



TEST REPORT

EN 50549-1:2019

**Requirements for generating plants to be connected in parallel
with distribution networks - Part 1-1:
Connection to a LV distribution network - Generating plants up
to and including Type B**

Report reference number : **PVGR200917N016**

Date of issue : 2021-01-21

Total number of pages : 105

Testing laboratory name : **Bureau Veritas Shenzhen Co., Ltd. Dongguan Branch**

Address : No. 96, Guantai Road (Houjie Section), Houjie Town, Dongguan City, Guangdong Province, 523942, People's Republic of China

Accreditation :



Applicant's name : **Shenzhen SOFARSOLAR Co., Ltd.**

Address : 401, Building 4, AnTongDa Industrial Park, District 68, XingDong Community, XinAn Street, BaoAn District, Shenzhen, China

Test specification

Standard..... : EN 50549-1:2019

with deviations according the national network and system protection for Greece.

Test Report Form No. : EN 50549-1 VER.0

TRF Originator : Bureau Veritas Shenzhen Co., Ltd. Dongguan Branch

Master TRF : Dated 2019-12-11

Test item description : **Hybrid inverter**

Trademark..... :





Model / Type : HYD 3000-EP, HYD 3680-EP, HYD 4000-EP, HYD 4600-EP,
HYD 5000-EP, HYD 5500-EP, HYD 6000-EP

This report is governed by, and incorporates by reference, CPS Conditions of Service as posted at the date of issuance of this report at <http://www.bureauveritas.com/home/about-us/our-business/cps/about-us/terms-conditions> and is intended for your exclusive use. Any copying or replication of this report to or for any other person or entity, or use of our name or trademark, is permitted only with our prior written permission. This report sets forth our findings solely with respect to the test samples identified herein. The results set forth in this report are not indicative or representative of the quality or characteristics of the lot from which a test sample was taken or any similar or identical product unless specifically and expressly noted. Our report includes all of the tests requested by you and the results thereof based upon the information that you provided to us. Measurement uncertainty is only provided upon request for accredited tests. You have 60 days from date of issuance of this report to notify us of any material error or omission caused by our negligence or if you require measurement uncertainty; provided, however, that such notice shall be in writing and shall specifically address the issue you wish to raise. A failure to raise such issue within the prescribed time shall constitute your unqualified acceptance of the completeness of this report, the tests conducted and the correctness of the report contents.

Ratings	HYD 3000-EP	HYD 3680-EP	HYD 4000-EP
Full load MPP DC voltage range [V] :	160-520V	180-520V	200-520V
Input DC voltage range[V]..... :	90-600V		
Input DC current [A]	Max. 13A/13A		
Output AC voltage [V]	L/N/PE, 230Vac, 50Hz		
Output AC current [A]..... :	15,0	16,0	20,0
Output power [W]	3000	3680	4000
Max. output power [VA]..... :	3300	3680	4400
Output DC voltage range [V]..... : [Battery charge]..... :	42-58V		
Input/Output DC current [A]..... : [Battery charge/discharge]	Max. 75A	Max. 80A	Max. 85A
Charge and discharge power[W]	Max. 3750	Max. 4000	Max. 4250
Output AC voltage [V]	L/N/PE, 230Vac, 50Hz		
Max. Input/Output AC current [A]..... : [Battery charge/discharge mode]	13,6	16,0	18,2
Max. Input/Output AC power [VA]..... : [Battery charge/discharge mode]	3000	3680	4000
Ratings	HYD 4600-EP	HYD 5000-EP	HYD 5500-EP
Full load MPP DC voltage range [V] :	230-520V	250-520V	250-520V
Input DC voltage range[V]..... :	90-600V		
Input DC current [A]	Max. 13A/13A		
Output AC voltage [V]	L/N/PE, 230Vac, 50Hz		
Output AC current [A]..... :	20,9	21,7	25,0
Output power [W]	4600	5000	5000
Max. output power [VA]..... :	4600	5000	5500
Output DC voltage range [V]..... : [Battery charge]..... :	42-58V		
Input/Output DC current [A]..... : [Battery charge/discharge]	Max. 100A		
Charge and discharge power[W]	Max. 5000		
Output AC voltage [V]	L/N/PE, 230Vac, 50Hz		
Max. Input/Output AC current [A]..... : [Battery charge/discharge mode]	20,9	22,7	22,7
Max. Input/Output AC power [VA]..... : [Battery charge/discharge mode]	4600	5000	5000

Ratings	HYD 6000-EP
Full load MPP DC voltage range [V] :	300-520V
Input DC voltage range[V]..... :	90-600V
Input DC current [A]	Max. 13A/13A
Output AC voltage [V]	L/N/PE, 230Vac, 50Hz
Output AC current [A]..... :	27,3
Output power [W]	6000
Max. output power [VA]..... :	6000
Output DC voltage range [V]..... :	42-58V
[Battery charge]..... :	
Input/Output DC current [A]..... :	Max. 100A
[Battery charge/discharge]	
Charge and discharge power[W]	Max. 5000
Output AC voltage [V]	L/N/PE, 230Vac, 50Hz
Max. Input/Output AC current [A]..... :	22,7
[Battery charge/discharge mode] :	
Max. Input/Output AC power [VA]..... :	5000
[Battery charge/discharge mode] :	

Testing Location	Bureau Veritas Shenzhen Co., Ltd. Dongguan Branch
Address	No. 96, Guantai Road (Houjie Section), Houjie Town, Dongguan City, Guangdong Province, 523942, People's Republic of China
Tested by (name and signature).....	Lukes Lin 
Approved by (name and signature).....	James Huang 
Manufacturer's name.....	Shenzhen SOFARSOLAR Co., Ltd.
Manufacturer address	401, Building 4, AnTongDa Industrial Park, District 68, XingDong Community, XinAn Street, BaoAn District, Shenzhen, China
Factory's name.....	Dongguan SOFAR SOLAR Co.,Ltd.
Factory address	1F - 6F, Building E, No. 1 JinQi Road, Bihu Industrial Park, Wulian Village, Fenggang Town, Dongguan City, Guangdong, China.

Document History			
Date	Internal reference	Modification / Change / Status	Revision
2021-01-21	Lukes Lin	Initial report was written	0
Supplementary information:			

Test items particulars

Equipment mobility : Permanent connection
 Operating condition : Continuous
 Class of equipment : Class I
 Protection against ingress of water .. : IP65 according to EN 60529
 Mass of equipment [kg] : Approx. 21.5kg

Test case verdicts

Test case does not apply
 to the test object : N/A
 Test item does meet
 the requirement : P(ass)
 Test item does not meet
 the requirement : F(ail)

Testing

Date of receipt of test item : 2020-09-17
 Date(s) of performance of test : 2020-09-17 to 2021-01-15

General remarks:

The test result presented in this report relate only to the object(s) tested. The report shall state compliance of the tested objects with the requirements of EN 50549-1. This report shall not be reproduced in part or in full without the written approval of the issuing testing laboratory.

"(see Annex #)" refers to additional information appended to the report.

"(see appended table)" refers to a table appended to the report.

Throughout this report a comma is used as the decimal separator.

This Test Report consists of the following documents:

1. Test Report
 - 4.4 Normal operating range
 - 4.5 Immunity to disturbances
 - 4.6 Active response to frequency deviation
 - 4.7 Power response to voltage variations and voltage changes
 - 4.8 EMC and power quality
 - 4.9 Interface protection
 - 4.10 Connection and starting to generate electrical power
 - 4.11 Ceasing and reduction of active power on set point
 - 4.13 Requirements regarding single fault tolerance of interface protection system and interface switch
2. Annex No. 1 – Pictures of the unit
3. Annex No. 2 – Test equipment list

Copy of marking plate

SOFAR
SOLAR
Hybrid Inverter

Model No: HYD 3000-EP

Max.DC Input Voltage	600V
Operating MPPT Voltage Range	90V~580V
MAX.PV Isc	2x18A
Battery Type	Lead-acid,Lithium-ion
Battery Voltage Range	42-58V
Max.Charging Current	75A
Max.Discharging Current	75A
Max.Charging&Discharging Power	3750W
Nominal Grid Voltage	230Vac
Nominal Output Voltage	230Vac
Max.Output Current	15.0A
Nominal Grid Frequency	50/60Hz
Power Factor	1(adjustable+/-0.8)
Nominal Output Power	3000W
Backup Rated Current	13.6A
Backup Rated Apparent Power	3000VA
Ingress Protection	IP 65
Operating Temperature Range	-30-+60°C
Protective Class	Class I

Manufacturer : Shenzhen SOFARSOLAR Co., Ltd.
Address : 401, Building 4, An TongDa Industrial Park,
District 68, XingDong Community,XinAn Street,
BaoAn District, Shenzhen, China
VDE0126-1-1,VDE-AR-N4105
G98,AS4777,UTE C15-712-1



SOFAR
SOLAR
Hybrid Inverter

Model No: HYD 3680-EP

Max.DC Input Voltage	600V
Operating MPPT Voltage Range	90V~560V
MAX.PV Isc	2x18A
Battery Type	Lead-acid,Lithium-ion
Battery Voltage Range	42-58V
Max.Charging Current	80A
Max.Discharging Current	80A
Max.Charging&Discharging Power	4000W
Nominal Grid Voltage	230Vac
Nominal Output Voltage	230Vac
Max.Output Current	16.0A
Nominal Grid Frequency	50/60Hz
Power Factor	1(adjustable+/-0.8)
Nominal Output Power	3680W
Backup Rated Current	16.0A
Backup Rated Apparent Power	3680VA
Ingress Protection	IP 65
Operating Temperature Range	-30-+60°C
Protective Class	Class I

Manufacturer : Shenzhen SOFARSOLAR Co., Ltd.
Address : 401, Building 4, An TongDa Industrial Park,
District 68, XingDong Community,XinAn Street,
BaoAn District, Shenzhen, China
VDE0126-1-1,VDE-AR-N4105
G98,AS4777,UTE C15-712-1



SOFAR
SOLAR
Hybrid Inverter

Model No: HYD 4000-EP

Max.DC Input Voltage	600V
Operating MPPT Voltage Range	90V~580V
MAX.PV Isc	2x18A
Battery Type	Lead-acid,Lithium-ion
Battery Voltage Range	42-58V
Max.Charging Current	85A
Max.Discharging Current	85A
Max.Charging&Discharging Power	4250W
Nominal Grid Voltage	230Vac
Nominal Output Voltage	230Vac
Max.Output Current	20.0A
Nominal Grid Frequency	50/60Hz
Power Factor	1(adjustable+/-0.8)
Nominal Output Power	4000W
Backup Rated Current	18.2A
Backup Rated Apparent Power	4000VA
Ingress Protection	IP 65
Operating Temperature Range	-30-+60°C
Protective Class	Class I

Manufacturer : Shenzhen SOFARSOLAR Co., Ltd.
Address : 401, Building 4, An TongDa Industrial Park,
District 68, XingDong Community,XinAn Street,
BaoAn District, Shenzhen, China
VDE0126-1-1,VDE-AR-N4105
G98,AS4777,UTE C15-712-1



SOFAR
SOLAR
Hybrid Inverter

Model No: HYD 4600-EP

Max.DC Input Voltage	600V
Operating MPPT Voltage Range	90V~580V
MAX.PV Isc	2x18A
Battery Type	Lead-acid,Lithium-ion
Battery Voltage Range	42-58V
Max.Charging Current	100A
Max.Discharging Current	100A
Max.Charging&Discharging Power	5000W
Nominal Grid Voltage	230Vac
Nominal Output Voltage	230Vac
Max.Output Current	20.9A
Nominal Grid Frequency	50/60Hz
Power Factor	1(adjustable+/-0.8)
Nominal Output Power	4600W
Backup Rated Current	20.9A
Backup Rated Apparent Power	4600VA
Ingress Protection	IP 65
Operating Temperature Range	-30-+60°C
Protective Class	Class I

Manufacturer : Shenzhen SOFARSOLAR Co., Ltd.
Address : 401, Building 4, An TongDa Industrial Park,
District 68, XingDong Community,XinAn Street,
BaoAn District, Shenzhen, China
VDE0126-1-1,VDE-AR-N4105
G98,AS4777,UTE C15-712-1



Copy of marking plate

SOFAR
SOLAR
Hybrid Inverter

Model No: HYD 5000-EP

Max. DC Input Voltage	600V
Operating MPPT Voltage Range	90V~580V
MAX. PV Isc	2x18A
Battery Type	Lead-acid, Lithium-ion
Battery Voltage Range	42-58V
Max. Charging Current	100A
Max. Discharging Current	100A
Max. Charging & Discharging Power	5000W
Nominal Grid Voltage	230Vac
Nominal Output Voltage	230Vac
Max. Output Current	21.7A
Nominal Grid Frequency	50/60Hz
Power Factor	1 (adjustable +/- 0.8)
Nominal Output Power	5000W
Backup Rated Current	22.7A
Backup Rated Apparent Power	5000VA
Ingress Protection	IP 65
Operating Temperature Range	-30~+60°C
Protective Class	Class I

Manufacturer: Shenzhen SOFARSOLAR Co., Ltd.
Address: 401, Building 4, An TongDa Industrial Park,
District 68, XingDong Community, XinAn Street,
BaoAn District, Shenzhen, China
VDE0126-1-1, VDE-AR-N4105
G98, AS4777, UTE C15-712-1



SOFAR
SOLAR
Hybrid Inverter

Model No: HYD 5500-EP

Max. DC Input Voltage	600V
Operating MPPT Voltage Range	90V~580V
MAX. PV Isc	2x18A
Battery Type	Lead-acid, Lithium-ion
Battery Voltage Range	42-58V
Max. Charging Current	100A
Max. Discharging Current	100A
Max. Charging & Discharging Power	5000W
Nominal Grid Voltage	230Vac
Nominal Output Voltage	230Vac
Max. Output Current	25.0A
Nominal Grid Frequency	50/60Hz
Power Factor	1 (adjustable +/- 0.8)
Nominal Output Power	5000W
Backup Rated Current	22.7A
Backup Rated Apparent Power	5000VA
Ingress Protection	IP 65
Operating Temperature Range	-30~+60°C
Protective Class	Class I

Manufacturer: Shenzhen SOFARSOLAR Co., Ltd.
Address: 401, Building 4, An TongDa Industrial Park,
District 68, XingDong Community, XinAn Street,
BaoAn District, Shenzhen, China
VDE0126-1-1, VDE-AR-N4105
G98, AS4777, UTE C15-712-1



SOFAR
SOLAR
Hybrid Inverter

Model No: HYD 6000-EP

Max. DC Input Voltage	600V
Operating MPPT Voltage Range	90V~580V
MAX. PV Isc	2x18A
Battery Type	Lead-acid, Lithium-ion
Battery Voltage Range	42-58V
Max. Charging Current	100A
Max. Discharging Current	100A
Max. Charging & Discharging Power	5000W
Nominal Grid Voltage	230Vac
Nominal Output Voltage	230Vac
Max. Output Current	27.3A
Nominal Grid Frequency	50/60Hz
Power Factor	1 (adjustable +/- 0.8)
Nominal Output Power	6000W
Backup Rated Current	22.7A
Backup Rated Apparent Power	5000VA
Ingress Protection	IP 65
Operating Temperature Range	-30~+60°C
Protective Class	Class I

Manufacturer: Shenzhen SOFARSOLAR Co., Ltd.
Address: 401, Building 4, An TongDa Industrial Park,
District 68, XingDong Community, XinAn Street,
BaoAn District, Shenzhen, China
VDE0126-1-1, VDE-AR-N4105
G98, AS4777, UTE C15-712-1



General product information:

The inverter converts DC voltage, generated by photovoltaic modules, into AC voltage. The units are single-phases hybrid-inverter. Rate of change of frequency (RoCoF) detection was used for LOM protection.

Description of the power circuit (Figure 1):

The charging current to batteries from PV array and grid, battery management unit is integrated in External Energy storage.

The Solar converter is a single-phase type, only one machine is allowed on each line conductor and power capacity is allowed to less than 11,08kW while is parallel to power generation system

The unit is providing EMC filtering at the output toward mains. The unit does not provide galvanic separation from input to output (transformerless). The output is switched off redundant by the high power switching bridge and a two relays. This assures that the opening of the output circuit will also operate in case of one error.

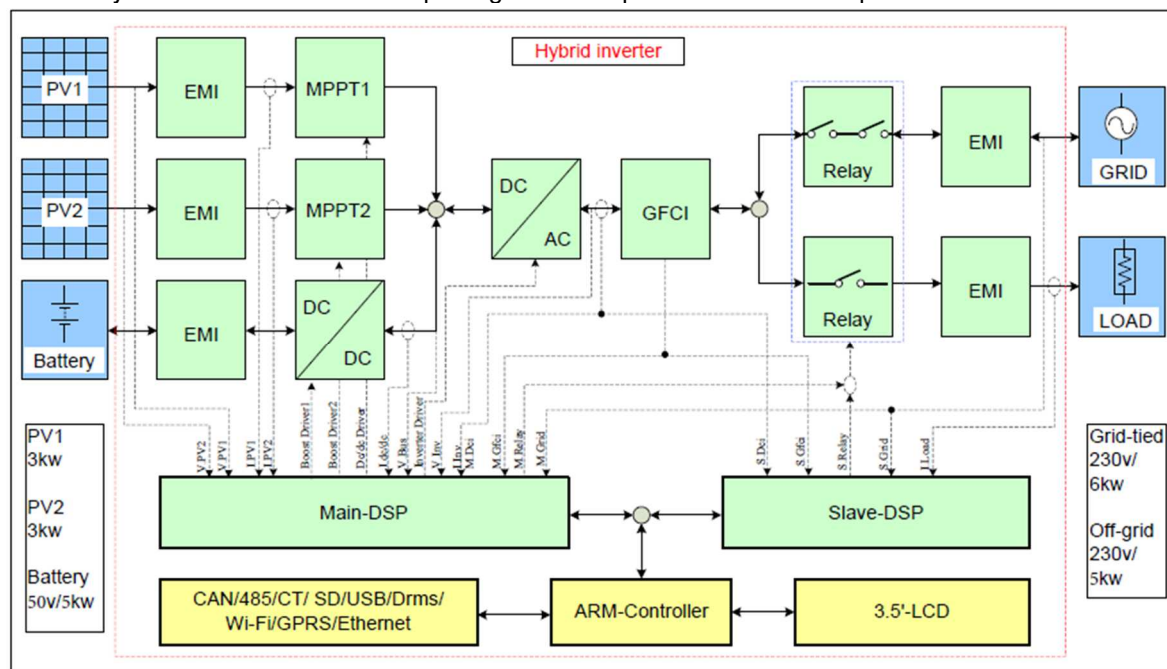

Figure 1 – Block diagram

The internal control is redundant built. It consists of Main DSP(U4) and slave DSP(U43).

The Main DSP(U4) can control the relays, measures voltage, and frequency, AC current with injected DC, insulation resistance and residual current, In addition it tests the array insulation resistance and the RCMU circuit before each start up.

The slave DSP(U43) is using for controlling the relays, measuring the voltage, frequency, inject a dc AC current, the residual current, and communicating with the master DSP(U4). And if the communicating with the master DSP, the slave DSP will disconnect the relays.

The unit provides two relays in series on Line and Neutral conductors. When single-fault applied to one relay, alarm an error code in display panel, another redundant relay provides basic insulation maintained between the PV array and the mains. All the relays are tested before start up. Both controllers Main DSP(U4), Slave DSP(U43) can open the relays.

Differences of the models:

The models HYD 3000-EP, HYD 3680-EP, HYD 4000-EP, HYD 4600-EP, HYD 5000-EP, HYD 5500-EP and HYD 6000-EP are completely identical and output power derated by software, except for the following table.

	HYD 3000-EP	HYD 3680-EP	HYD 4000-EP	HYD 4600-EP	HYD 5000-EP	HYD 5500-EP	HYD 6000-EP
R332, R334, R336	(NC, 0Ω, NC)			(0Ω, NC, 0Ω)			
Bus capacitance	6pcs			8pcs			
INV inductor	1,035mH			0,75mH			
R123, R132	(499Ω, 499Ω)			(1.5kΩ, 1.5kΩ)			

The product was tested on:

Hardware version: V001

Software version: V02000

General remarks:

The test results presented in this report relate only to the object(s) tested.

This document may be published or passed on in full only. Extraction of parts needs the written permission of Bureau Veritas Consumer Products Services GmbH.

"(see Annex #)" refers to additional information appended to the report.

"(see appended table)" refers to a table appended to the report.

Throughout this report a comma is used as the decimal separator.

The following suffixes are used for variables in tables and figures:

- "P_n" for the nominal active power:
 $P_n = U_n \times I_n \times \cos \varphi_n$ (single-Phase); $P_n = \sqrt{3} U_n \times I_n \times \cos \varphi_n$ (three-Phase)
- "P_M" for the momentary power
- "(c)" for over-excited
- "(i)" for under-excited

Active and reactive power:

The regarded system of the voltage and current vectors is the load view (Figure 2):

- If the inverter feeds to the grid the active power is measured with negative sign. For the sake of reading the document the measured active infeed power has a positive sign

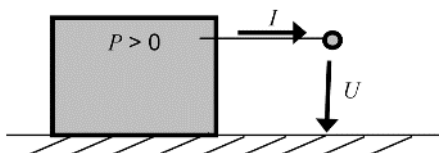

- If the inverter consumes inductive reactive power the reactive power is marked "inductive" or has a positive sign.
- If the inverter consumes capacitive reactive power the reactive power is marked "capacitive" or has a negative sign.

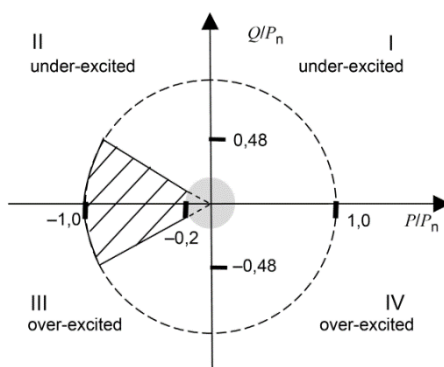

Figure 2

Default interface protection settings according EN 50549-1:2019:

Parameter	Max. disconnection time	Min. operate time	Trip value
Over voltage – stage 1	3 s	0,1 s	230V +10% (253,0 V)
Over voltage – stage 2	0,2 s	0,1 s	230V +15% (264,5 V)
Under voltage – stage 1	1,5 s	1,2 s	230V -15% (195,5V)
Over frequency	0,5 s	0,3 s	52 Hz
Under frequency	0,5 s	0,3 s	47,5 Hz
Reconnection settings for voltage	$0,85 U_n \leq U \leq 1,10 U_n$		
Connection settings for frequency (Normal operational start-up)	$49,5 \text{ Hz} \leq f \leq 50,1 \text{ Hz}$		
Reconnection settings for frequency (Automatic reconnection after tripping)	$49,5 \text{ Hz} \leq f \leq 50,2 \text{ Hz}$		
Reconnection time	$\geq 60 \text{ s}$		
Active power gradient after reconnection	$10\% P_n/\text{min}$		
Permanent DC-injection	0,5% of rated inverter output current or 20mA		
Loss of mains according EN 62116	Inverter shall disconnect within 2 s.		
<p>The stated currents and voltages are 'true r.m.s.'-values. The voltages in this table are - phase-to-neutral in 230 V single phase systems and 230/400 V systems, - phase-to-phase in a multiphase 230 V system.</p>			
<p>Tolerances on trip values:</p> <ul style="list-style-type: none"> - Voltage: $\pm 1\%$ of U_n - Frequency: $\pm 0,05 \text{ Hz}$ - Disconnection time : $\pm 10\%$ 			

EN 50549:2019, clause 4: Tests

Clause	Test requirement (According to table C.1)	Result
4.4	Normal operating range	P
4.5	Immunity to disturbances	P
4.6	Active response to frequency deviation	P
4.7	Power response to voltage variations and voltage changes	P
4.8	EMC and power quality	P
4.9	Interface protection	P
4.10	Connection and starting to generate electrical power	P
4.11	Ceasing and reduction of active power on set point	P
4.12	Remote information exchange	N/A
4.13	Requirements regarding single fault tolerance of interface protection system and interface switch	P

EN 50549-1:2019: Normal operating range

Clause	Test requirement	Test procedure according standard	Result
4.4.2	Power response to over-frequency	EN 50438, Annex D.3.1	P
4.4.3	Power response to under-frequency	G99/1-4, clause A.7.3.2	P
4.4.4	Continuous operating voltage range	EN 50438, Annex D.3.1	P

4.4.2 Operating frequency range					P
4.4.4 Continuous operating voltage range					
Setting values	Over-voltage [V]:				253
	Under-voltage [V]:				195,5
	Over-frequency [Hz]:				51,5
	Under-frequency [Hz]:				47,5
<ul style="list-style-type: none"> - Test 1: U = 195,5 V; f = 47,5 Hz; P = 1,00 S_n; cosφ = 1 - Test 2: U = 195,5 V; f = 48,5 Hz; P = 1,00 S_n; cosφ = 1 - Test 3: U = 253,0 V; f = 51,5 Hz; P = 1,00 S_n; cosφ = 1 - Test 4: U = 230,0 V; f = 50,0 Hz; Voltage Phase jumps Change +20 degrees P = 1,00 S_n; cosφ = 1 - Test 5: U = 230,0 V; f = 50,0 to 50,5 Hz; RoCoF=1Hz/s; P = 1,00 S_n; cosφ = 1 					
Test result:					
Test sequence	Voltage [V]	Frequency [Hz]	Output power [kW]	Cos φ	
Test1	195,36	47,50	5,949	0,9939	
Test2	195,41	48,50	5,948	0,9977	
Test3	253,72	51,50	6,032	0,9972	
Test4	230,83	50,00	6,017	0,9995	
Test5	230,97	50,50	6,020	0,9989	
<p>Note:</p> <p>Test method refer clause D.3.1 of EN 50438:2013.</p> <p>During the tests the interface protection was disabled.</p> <p>Operation at reduced power is allowed during test 1, equal to the maximum power that can be supplied on reaching the maximum output current limit ($P \geq 0,85 S_n$).</p> <p>During the sequence of test 3, automatic adjustment to reduce power in the case of over-frequency was disabled.</p> <p>The tests had been performed on the HYD 6000-EP is valid for the HYD 5500-EP, HYD 5000-EP, HYD 4600-EP, HYD 4000-EP, HYD 3680-EP and HYD 3000-EP, since it is identical in hardware and software construction except output power derated by software.</p> <p>The test results refer to the test report "PVTR200917N016" issued by Bureau Veritas Shenzhen Co., Ltd. Dongguan Branch, dated on 2021.01.20.</p>					

4.4.3 Minimal requirement for active power delivery at under-frequency

P

Graph of frequency a) to b) to c) to d) to e):

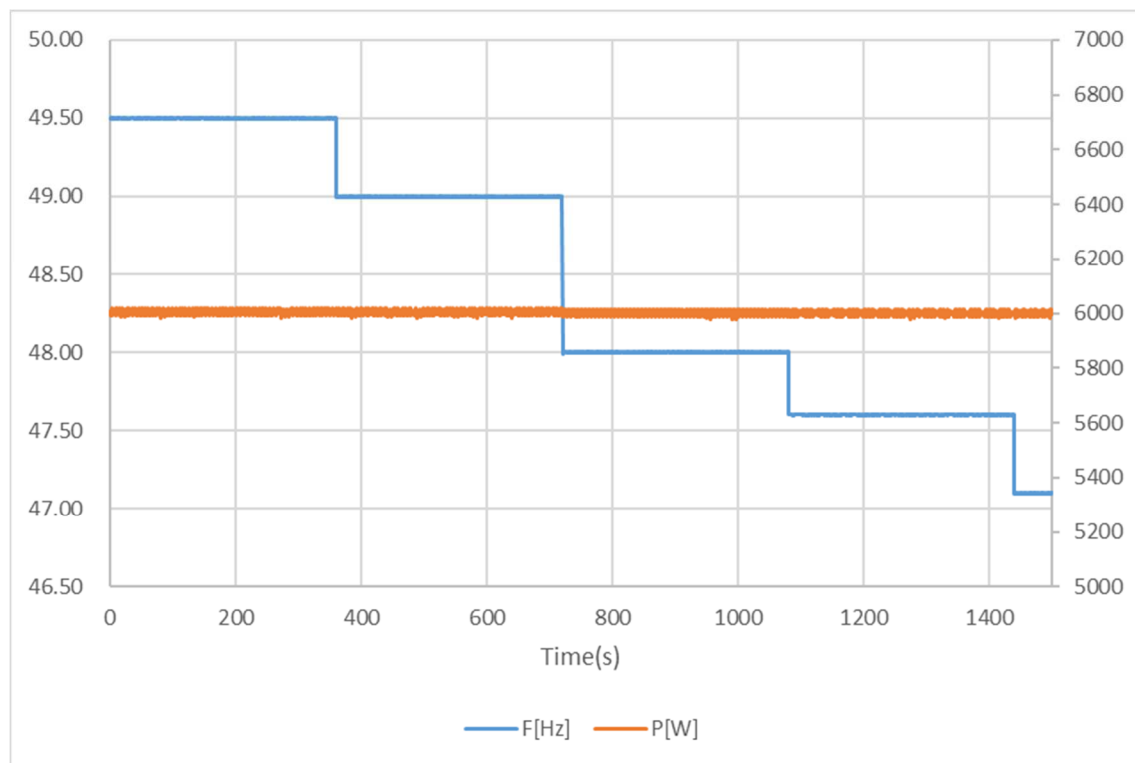

Test result:

	Switch to:				
5-min mean value (each)	a) 49,50 Hz	b) 49,00 Hz	c) 48,00 Hz	d) 47,60 Hz	e) 47,10 Hz
Frequency [Hz]:	49,50	49,00	48,00	47,60	47,10
Active power [kW]:	6,005	6,004	6,002	6,000	6,000
$\Delta P/P_n$ [%] :	0	0	0	0	0

Assessment criterion:

Test method refer clause A.7.3.2 of G99/1-4

The frequency should then be set to 49,5 Hz for 5 minutes. The output should remain at 100% of registered Capacity.

The frequency should then be set to 49,0 Hz and once the output has stabilised, held at this frequency for 5 minutes. The Active Power output must not be below 99% of registered Capacity.

The frequency should then be set to 48,0 Hz and once the output has stabilised, held at this frequency for 5 minutes. The Active Power output must not be below 97% of registered Capacity.

The frequency should then be set to 47,6 Hz and once the output has stabilised, held at this frequency for 5 minutes. The Active Power output must not be below 96.2% of registered Capacity.

The frequency should then be set to 47,1 Hz and held at this frequency for 20s. The Active Power output must not be below 95,0% of registered Capacity and the Synchronous Power Generating Module must not trip in less than the 20s of the test.

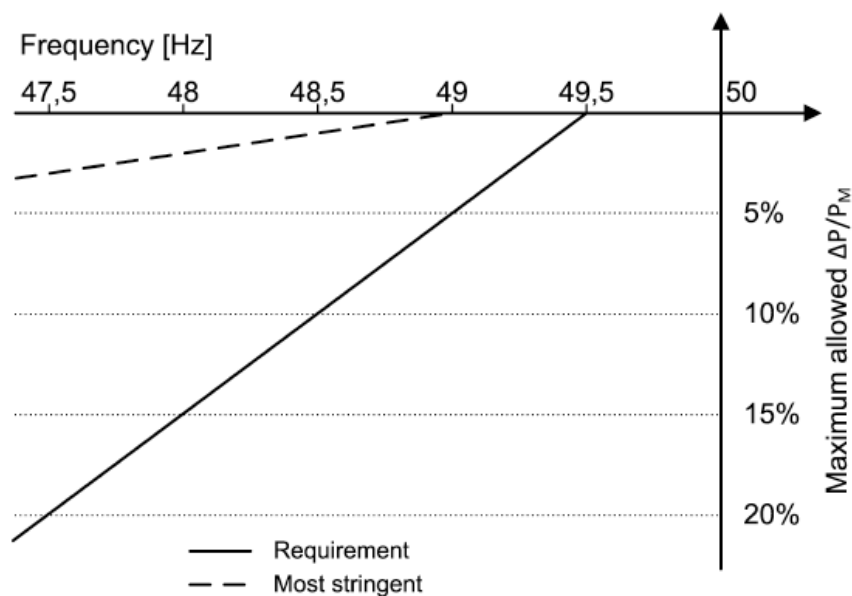

Maximum allowable power reduction in case of under-frequency

Note:

The tests had been performed on the HYD 6000-EP is valid for the HYD 5500-EP, HYD 5000-EP, HYD 4600-EP, HYD 4000-EP, HYD 3680-EP and HYD 3000-EP, since it is identical in hardware and software construction except output power derated by software.

The test results refer to the test report "PVTR200917N016" issued by Bureau Veritas Shenzhen Co., Ltd. Dongguan Branch, dated on 2021.01.20.

EN 50549-1:2019: Immunity to disturbances

Clause	Test requirement	Test procedure according standard	Result
4.5.2	Rate of change of frequency (RoCoF) immunity	G99/1-4:2019, clause A.7.1.2.6	P
4.5.3	Low voltage ride through (LVRT)	VDE V 0124-100:2019-02 (Draft), clause 5.8.3.	P
4.5.4	High voltage ride through (HVRT)	VDE V 0124-100:2019-02 (Draft), clause 5.8.3.	P
4.7.4	Zero current mode for converter connected generating plants	VDE V 0124-100:2019-02 (Draft), clause 5.8.3.	P

4.5.2 Rate of change of frequency (ROCOF) immunity(defual settings)				P
	Start Frequency	Change	End Frequency	Confirm no trip
Positive Frequency drift	49Hz	+2Hz/sec	51Hz	No trip
Negative Frequency drift	51Hz	-2Hz/sec	49Hz	No trip

Note:

Test method refer clause A.7.1.2.6 of G99/1-4:2019.

Hold for 10 s

Manufacturers considering new designs should allow for the RoCoF where stability is required to be increased to, up to 2Hz per second, as proposed in the new European network codes, which are expected to come into force over the period 2014/2015. Under these conditions RoCoF will cease to be an effective loss of mains protection and is unlikely to be permitted in future revisions of this document.

For the step change test the SSEG should be operated with a measureable output at the start frequency and then a vector shift should be applied by extending or reducing the time of a single cycle with subsequent cycles returning to the start frequency. The start frequency should then be maintained for a period of at least 10 seconds to complete the test. The SSEG should not trip during this test.

For frequency drift tests the SSEG should be operated with a measureable output at the start frequency and then the frequency changed in a ramp function at 0,95Hz per second to the end frequency. On reaching the end frequency it should be maintained for a period of at least 10 seconds. The SSEG should not trip during this test.

The tests had been performed on the HYD 6000-EP is valid for the HYD 5500-EP, HYD 5000-EP, HYD 4600-EP , HYD 4000-EP, HYD 3680-EP and HYD 3000-EP, since it is identical in hardware and software construction except output power derated by software.

The test results refer to the test report "PVTR200917N016" issued by Bureau Veritas Shenzhen Co., Ltd. Dongguan Branch, dated on 2021.01.20.

4.5.3	Low voltage ride through (LVRT)	P
4.5.4	High voltage ride through (HVRT)	
4.7.4	Zero current mode for converter connected generating plants	

General:

If the voltage on the generator terminals falls below $<0.8 U_n$ and if the generator terminals exceed the voltage of $> 1.15 U_n$ (start of fault), generator must pass through voltage dips without any current being drawn into the grid Network operator (limited dynamic network support).

This requirement is met if, for a voltage dip below $0.8 U_n$ or at a voltage increase above $1.15 U_n$, the injected current of the generating unit (s) and / or the memory 60 ms after occurrence of this voltage dip in any outer conductor 20% of the rated current I_r and does not exceed $> 10\% I_r$ after 100 ms.

After the voltage returned to continuous operating voltage range of $-15\% U_n$ to $+10\% U_n$, 90 % of pre fault power or available power whichever is the smallest shall be resumed as fast as possible, but at the latest within 1 s unless the DSO and the responsible party requires another value.

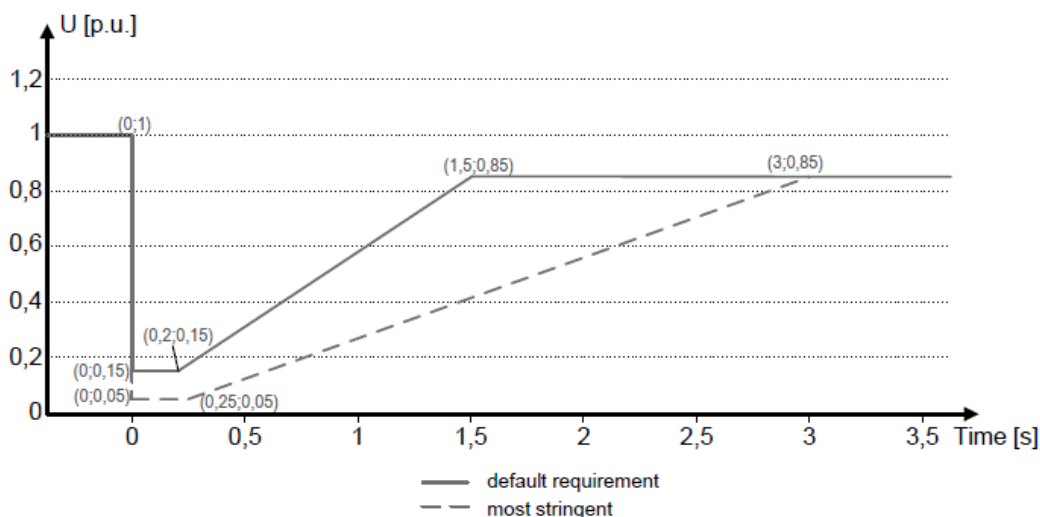

Figure 6 — Low voltage ride through capability for non-synchronous generating technology

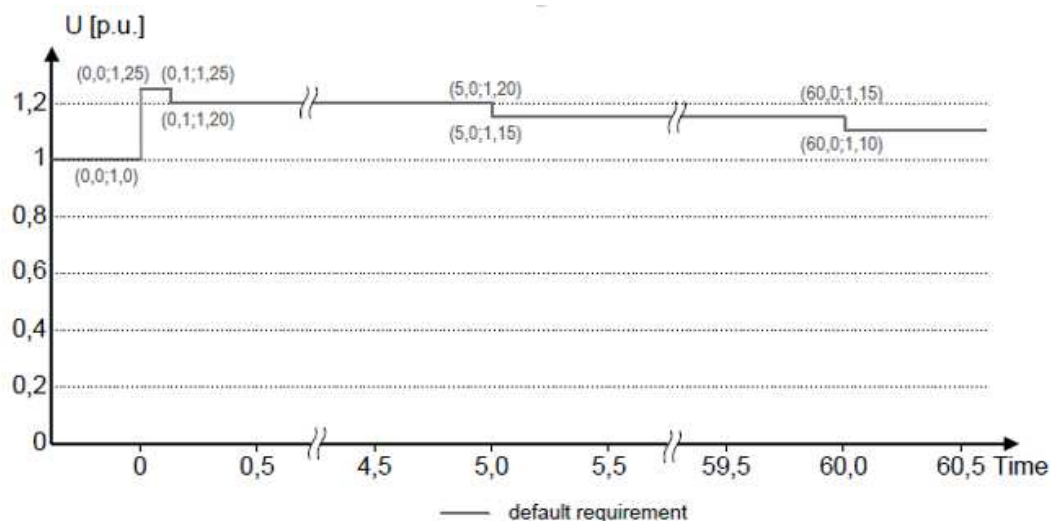

Figure 8 — Over-voltage ride through capability

Test	Drop depth requirement [p.u. U_n]	Symmetry	Fault duration [ms]	Output power level		k-factor	Test no.
				P set point (P_{rE} / p.u.)	Q set point (Q / p.u.)		
1.A.1	0,03	Symmetrical	250	1,0	0,00	0	1.A.1
1.A.2				0,2			1.A.2
1.D.1		Asymmetrical		1,0			1.D.1
1.D.2				0,2			1.D.2
1.B.1		Single phase*		1,0			1.B.1
1.B.2				0,2			1.B.2
2.A.1	0,31	Symmetrical	1300	1,0	0,00	0	2.A.1
2.A.2				0,2			2.A.2
2.D.1		Asymmetrical		1,0			2.D.1
2.D.2				0,2			2.D.2
2.B.1		Single phase*		1,0			2.B.1
2.B.2				0,2			2.B.2
3.A.1	0,82	Symmetrical	3000	1,0	0,00	0	3.A.1
3.A.2				0,2			3.A.2
3.D.1		Asymmetrical		1,0			3.D.1
3.D.2				0,2			3.D.2
3.B.1		Single phase*		1,0			3.B.1
3.B.2				0,2			3.B.2
OV1	1,25	Symmetrical	100	1,0	0,00	0	OV1
OV2	1,20		5000	1,0			OV2
OV3	1,15		60000	1,0			OV3

Note:

For every kind of voltage dip a test without load has to be performed in order to prove that the test condition was fulfilled. The voltage has to drop to AT LEAST the defined depth level. An exception can be considered in case no current is supplied during dips.

* Single phase = "choose Typ 7 at BV-Lab Studio" \triangleq LVRT Typ B

Graph of FRT test one				
Test result:				
List of tests	Residual amplitude of phase-to-phase voltage [p.u. U_n]	Duration limit [ms]	Duration [ms]	Result
$P_{E_{max}}$ in %	100% \pm 5%			
1.B.1- Single phase	0,03	250 \pm 20	257	Pass
2.B.1- Single phase	0,31	1300 \pm 20	1305	Pass
3.B.1- Single phase	0,82	3000 \pm 20	3006	Pass
$P_{E_{max}}$ in %	20% \pm 5%			
1.B.2- Single phase	0,03	250 \pm 20	259	Pass
2.B.2- Single phase	0,31	1300 \pm 20	1310	Pass
3.B.2- Single phase	0,82	3000 \pm 20	3000	Pass
$P_{E_{max}}$ in %	100% \pm 5%			
OV1- Symmetrical	1,25	100 \pm 20	100	Pass
OV2- Symmetrical	1,20	5000 \pm 20	5000	Pass
OV3- Symmetrical	1,15	60000 \pm 20	60001	Pass
Test conditions:				
Voltage simulator fall and rise time: < 20ms				
Used sample rate: 10 kHz				
Note:				
The tests had been performed on the HYD 6000-EP is valid for the HYD 5500-EP, HYD 5000-EP, HYD 4600-EP , HYD 4000-EP, HYD 3680-EP and HYD 3000-EP, since it is identical in hardware and software construction except output power derated by software.				
The test results refer to the test report "PVTR200917N016" issued by Bureau Veritas Shenzhen Co., Ltd. Dongguan Branch, dated on 2021.01.20.				

Test 1.B.1-Single phase fault ($U/U_{nom} = 0,03$); $P = 100\% \pm 5\% P_n$

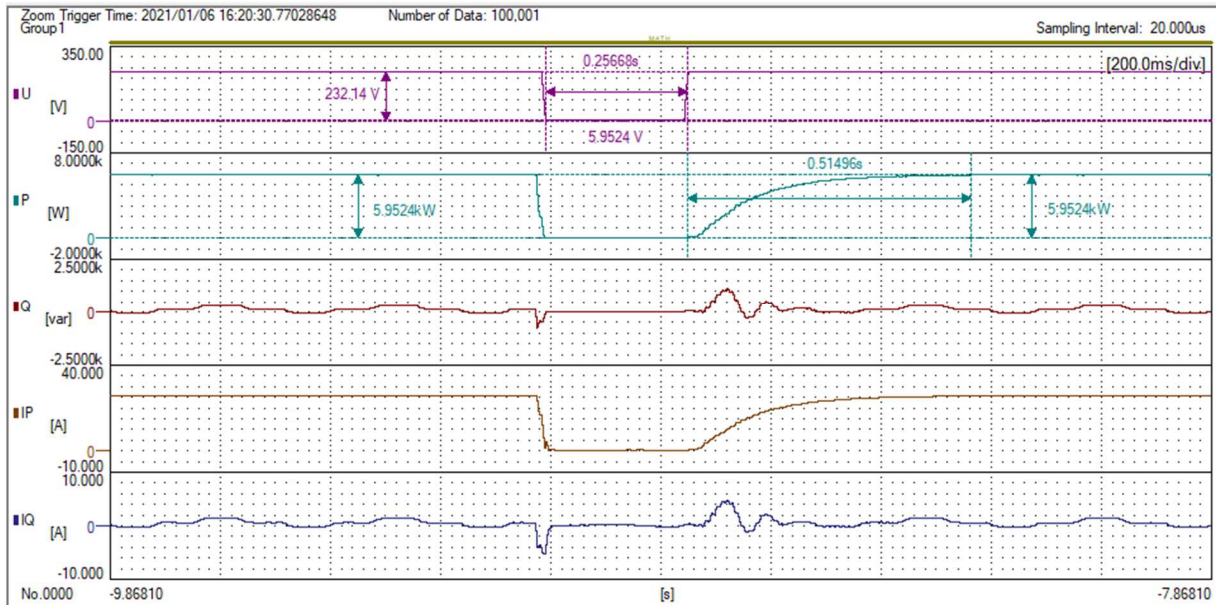

Test 2.B.1-Single phase fault ($U/U_{nom} = 0,31$); $P = 100\% \pm 5\% P_n$

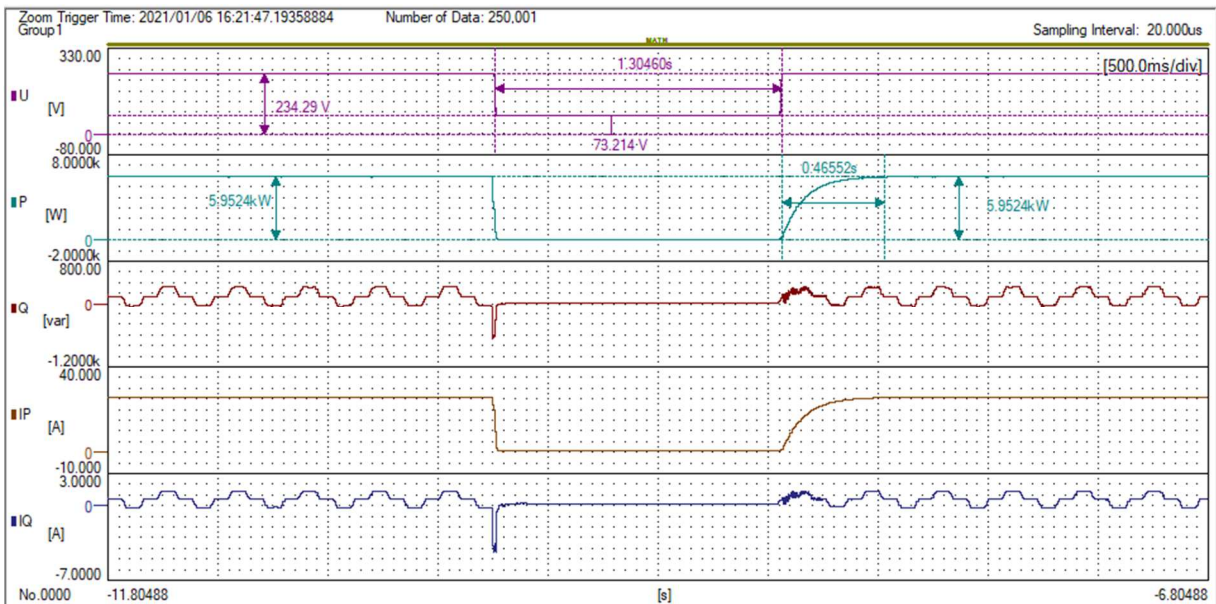

Test 3.B.1-Single phase fault ($U/U_{nom} = 0,82$); $P = 100\% \pm 5\% P_n$

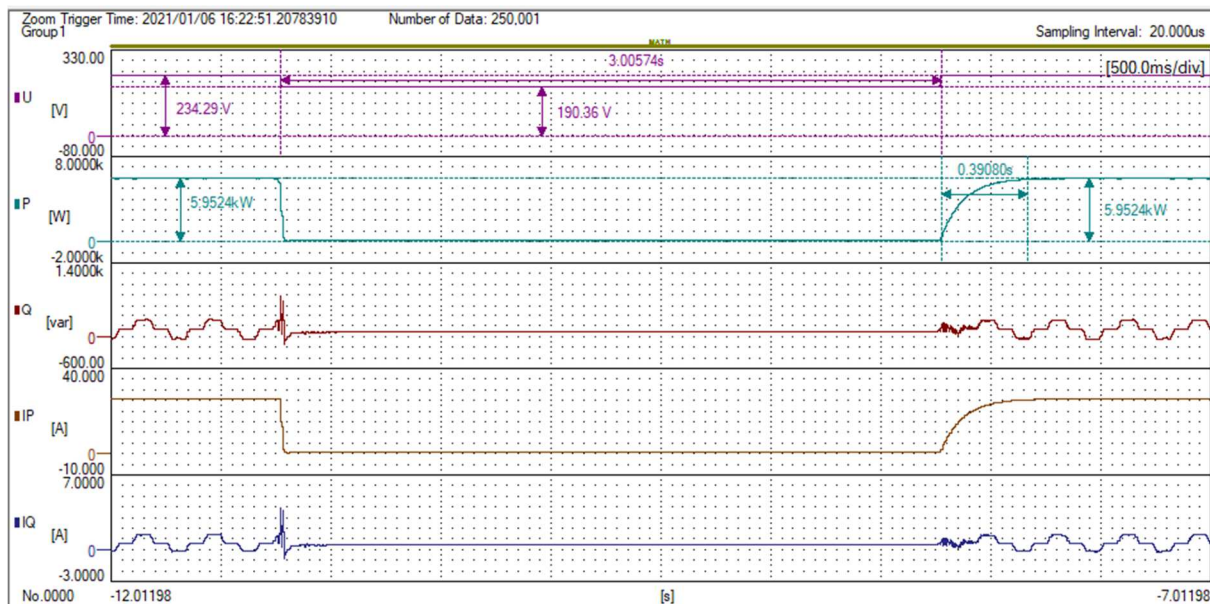

Test 1.B.1-Single phase fault ($U/U_{nom} = 0,03$); $P = 20\% \pm 5\% P_n$

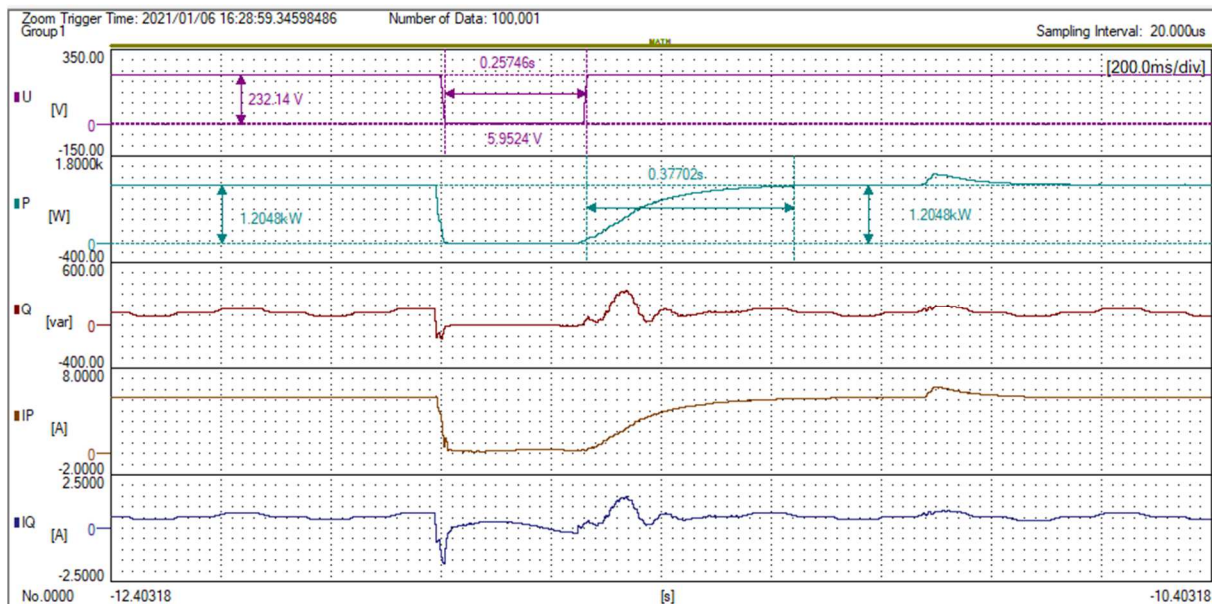

Test 2.B.1-Single phase fault ($U/U_{nom} = 0,31$); $P = 20\% \pm 5\% P_n$

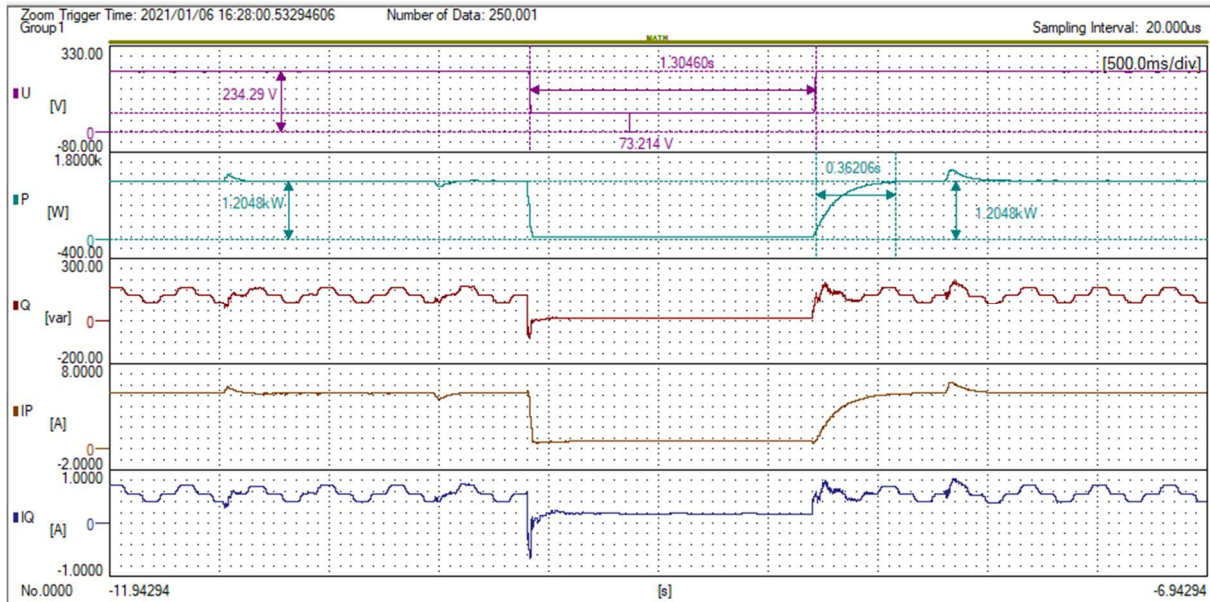

Test 3.B.1-Single phase fault ($U/U_{nom} = 0,82$); $P = 20\% \pm 5\% P_n$

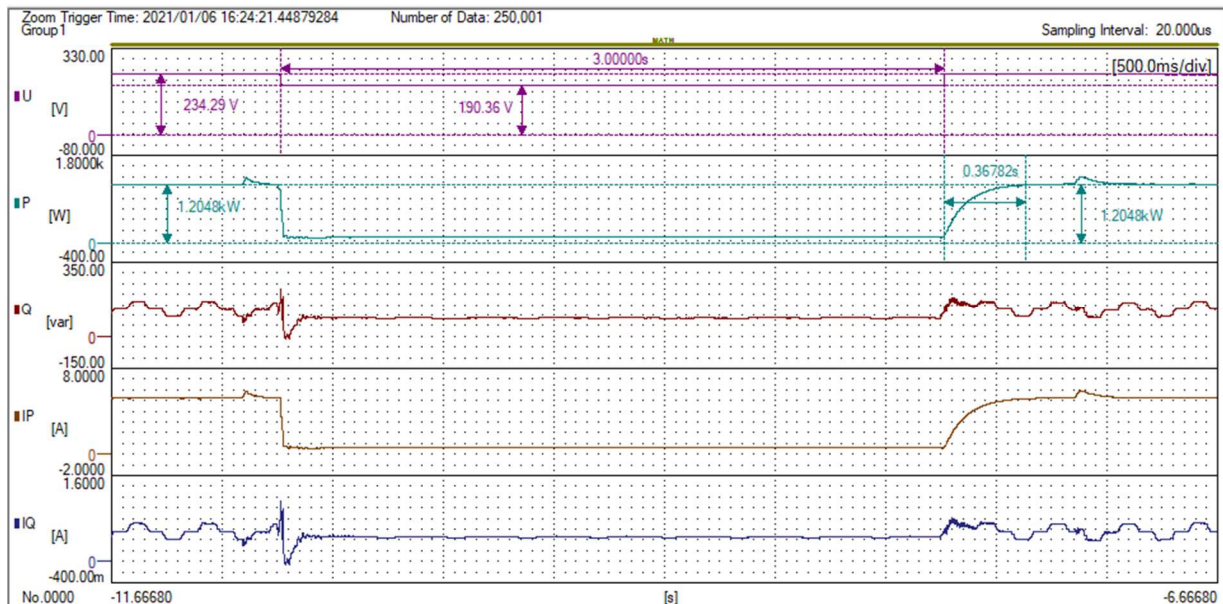

Test OV1-Symmetrical fault ($U/U_{nom} = 1,25$); $P = 100\% \pm 5\% P_n$

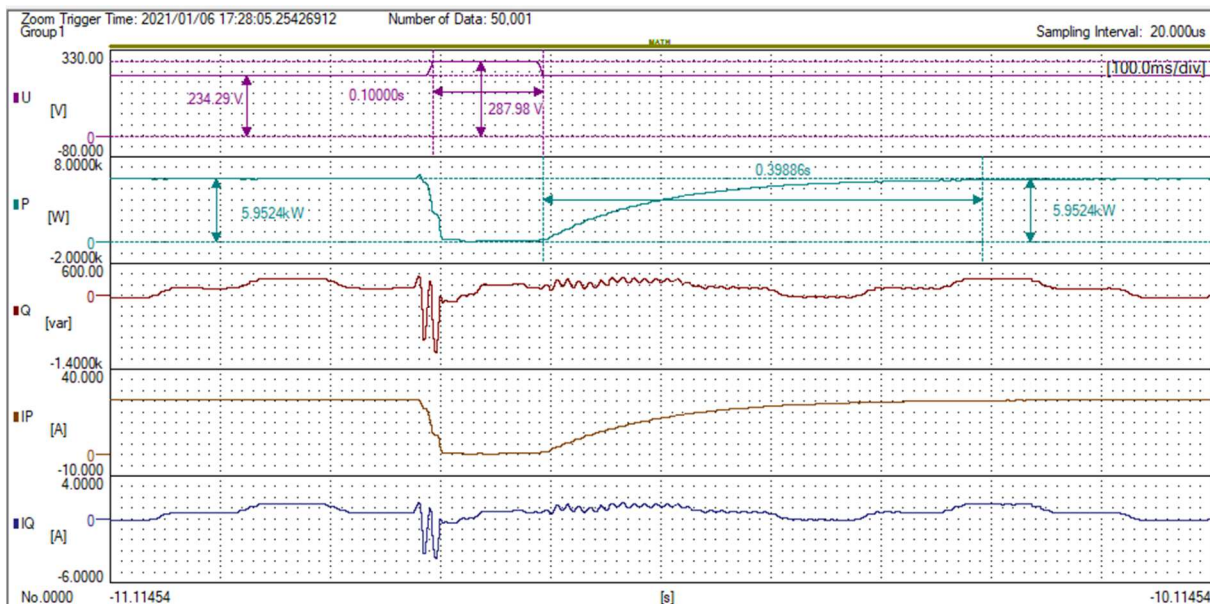

Test OV2-Symmetrical fault ($U/U_{nom} = 1,20$); $P = 100\% \pm 5\% P_n$

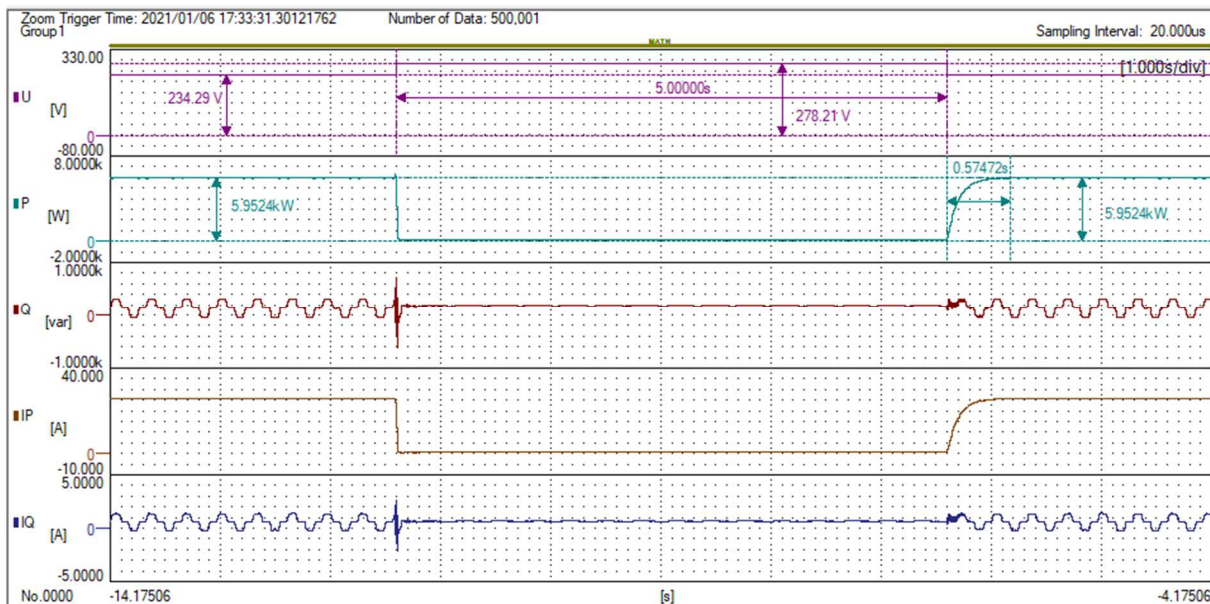

Test OV3-Symmetrical fault ($U/U_{nom} = 1,15$); $P = 100\% \pm 5\% P_n$

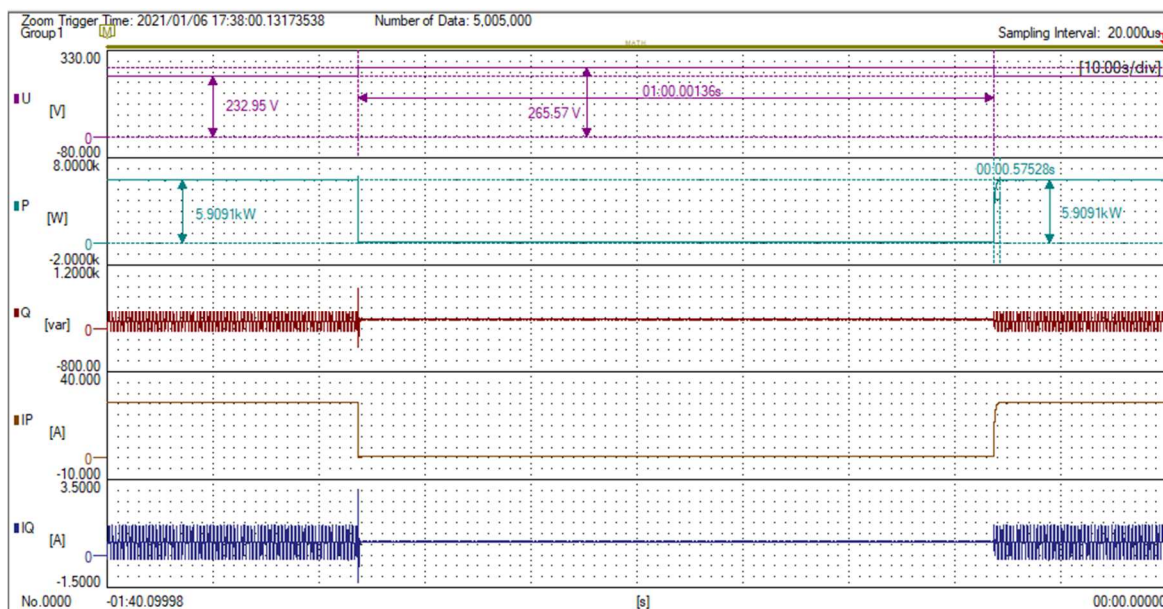

EN 50549-1:2019: Active response to frequency deviation

Clause	Test requirement	Test procedure according standard	Result
4.6.1	Power response to over-frequency	VDE V 0124-100:2019-02 (Draft), clause 5.4.4	P
4.6.2	Power response to under-frequency	VDE V 0124-100:2019-02 (Draft), clause 5.4.6	P

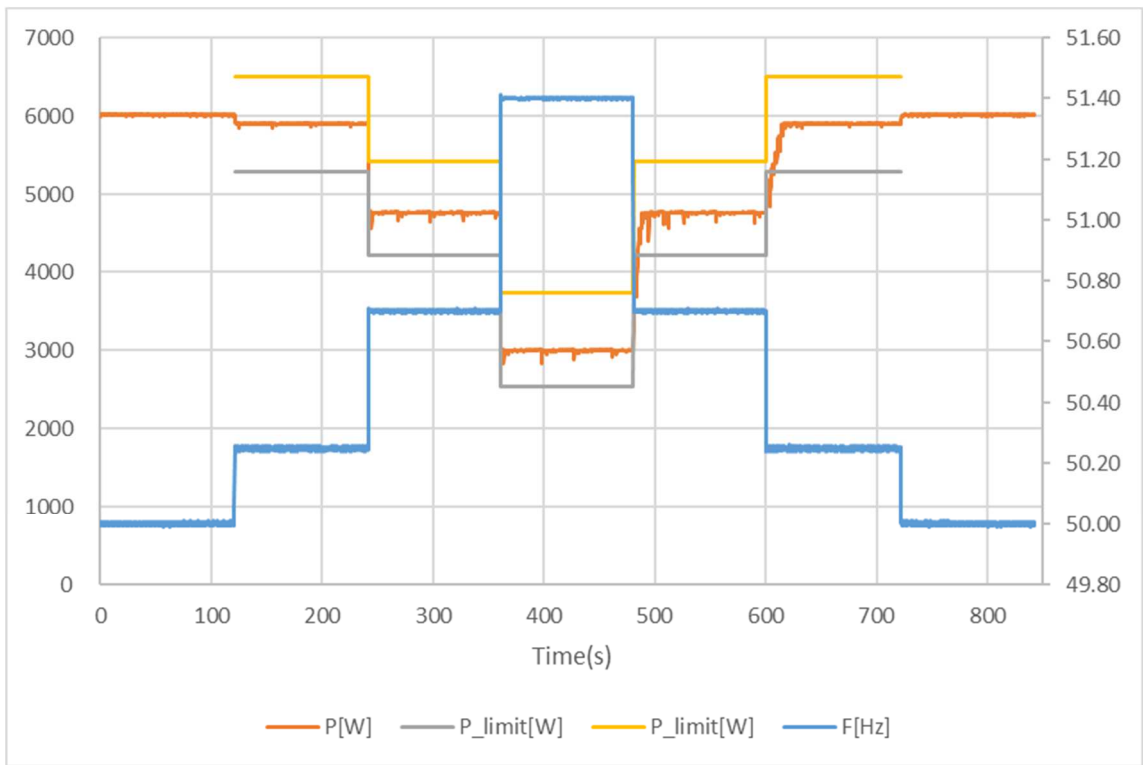
4.6.1 Power response to over-frequency (For synchronous generating and Electrical Energy Storage System unit (EES) only)							P
Test result: HYD 6000-EP							
1-min mean value [Hz]:	a) 50,00	b) 50,25	c) 50,70	d) 51,40	e) 50,70	f) 50,25	g) 50,00
1. Measurement a) to g): Active power output = 100% $P_{E_{max}}$ s=5% (40% $P_{E_{max}}$ / Hz), threshold frequency for start/return: 50,2Hz							
Frequency [Hz]:	50,00	50,25	50,70	51,40	50,70	50,25	50,00
P_M [kW]:	N/A	5,896	4,818	3,136	4,818	5,897	N/A
P_{E60} [kW]:	6,018	5,901	4,766	3,000	4,766	5,901	6,017
$\Delta P_{E60}/P_M$ [%]:	N/A	0,08	-0,86	-2,28	-0,86	0,07	N/A
2. Measurement a) to g): Active power output 60% after freezing = 100% $P_{E_{max}}$ s=5% (40% $P_{E_{max}}$ / Hz), threshold frequency for start/return: 50,2Hz							
Frequency [Hz]:	50,00	50,25	50,70	51,40	50,70	50,25	50,00
P_M [kW]:	N/A	3,526	2,448	0,766	2,448	3,526	N/A
P_{E60} [kW]:	3.647	3,529	2,414	0,669	2,415	3,528	20,079
$\Delta P_{E60}/P_M$ [%]:	N/A	0,05	-0,57	-1,62	-0,54	0,04	N/A
Limit $\Delta P/P_{1min}$:	$\pm 10\%$ of $P_{E_{max}}$						
Graph of Measurement 1.: Active power output > 80% $P_{E_{max}}$							
							

Graph of Measurement 2.:Active power output 40% and 60% after freezing > 80% P_n

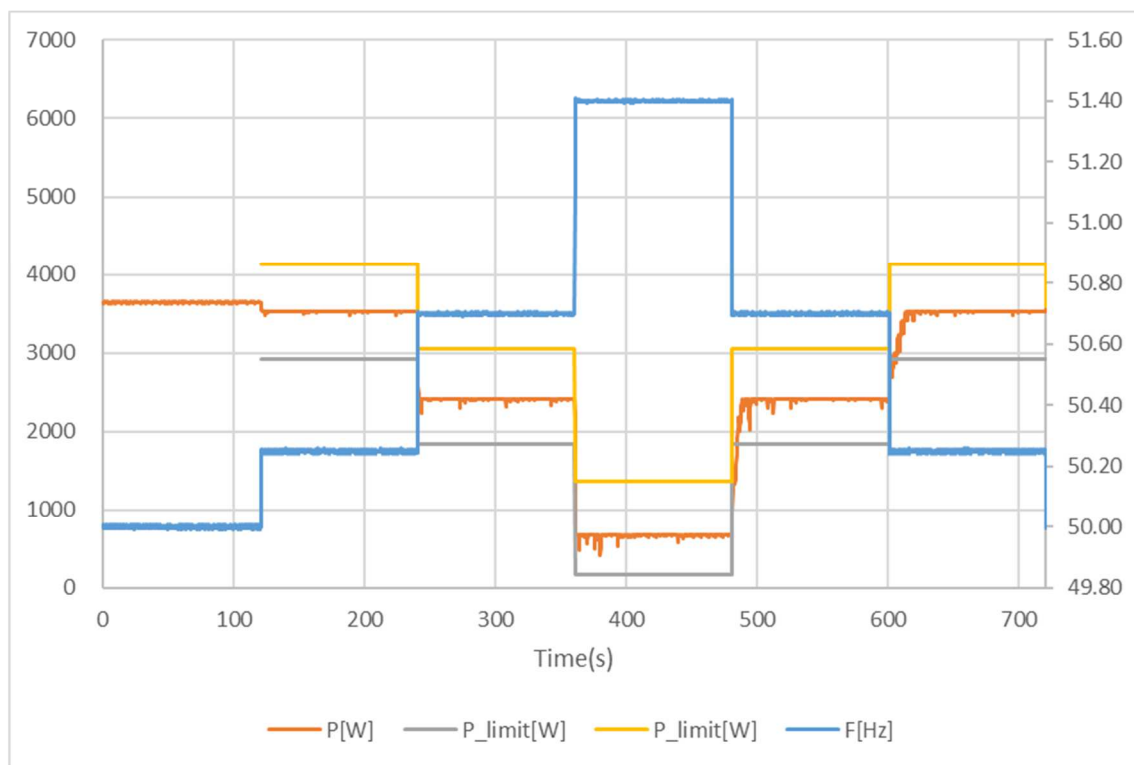

Graph of power gradient:

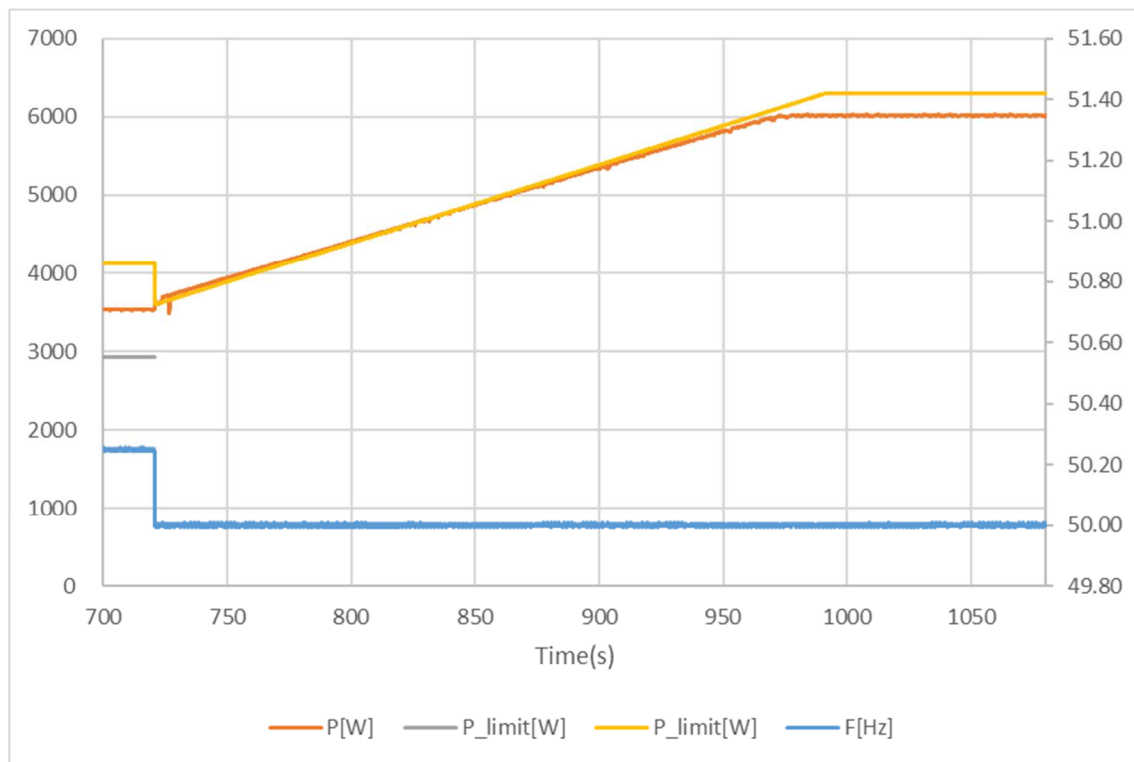

Test:

The test is conducted for two powers. First, the test must start at a power =100% $P_{E_{max}}$ ("Measurement 1"), and in a second test, for a power 60% $P_{E_{max}}$ ("Measurement 2"). In the second test, after freezing of the P_M , the available active power output must be increased to a value =100% $P_{E_{max}}$, and after the network frequency of 50,2 Hz is fallen below, the rise of the active power gradient must be recorded.

Point g) must be held until the micro-generator is again feeding in with the active power output available.

Assessment criterion:

For $f = 50,2$ Hz, the value of the P_M active power currently being generated is "frozen".

a) For adjustable micro-generators when:

- 1) the active power reduces between measuring points b) and f) given above with the set gradient P_M per Hz for a increasing frequency (or rises for a frequency decreasing again).
- 2) the maximum active power gradient occurring in point is less than the configured maximum active power per minute
- 3) the reaction value of the setpoint determined by the gradient characteristic curve does not differ from $P_{E_{max}}$ by more than $\pm 10\%$.
- 4) the settling time is equal or below 2 s with an intentional delay set to zero

b) For partly adjustable micro-generators

- 1) when they behave as in a) within their adjustment range, and
- 2) when, outside the adjustable range, the power fed in on leaving the adjustment range remains constant until shutdown. Shutdown must be no later than at 51,5 Hz.

Note:

The test method refer to clause 5.4.4 of VDE V 0124-100:2019-02 (Draft).

The tests had been performed on the HYD 6000-EP is valid for the HYD 5500-EP, HYD 5000-EP, HYD 4600-EP, HYD 4000-EP, HYD 3680-EP and HYD 3000-EP, since it is identical in hardware and software construction except output power derated by software.

The test results refer to the test report "PVTR200917N016" issued by Bureau Veritas Shenzhen Co., Ltd. Dongguan Branch, dated on 2021.01.20.

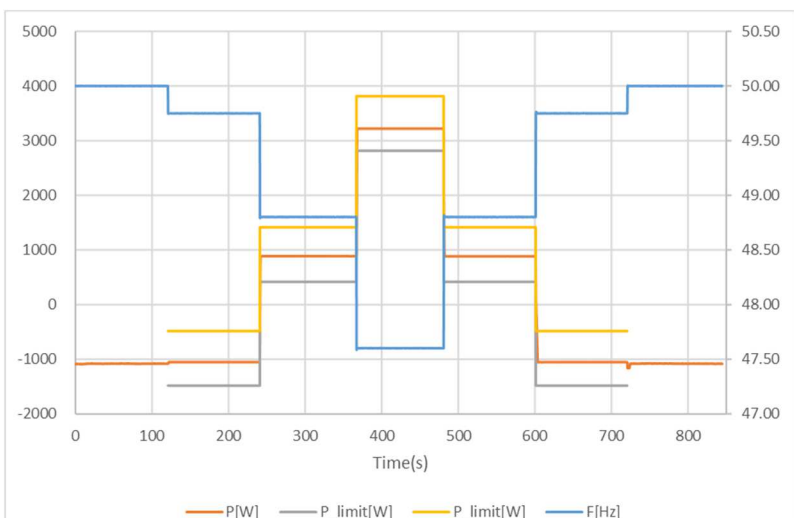
4.6.2 Power response to over-frequency (For synchronous generating and Electrical Energy Storage System unit (EES) only)							P
Test result: HYD 6000-EP							
1-min mean value [Hz]:	a) 50,00	b) 49,75	c) 48,80	d) 47,60	e) 48,80	f) 49,75	g) 50,00
1. Measurement a) to g): Active power output = $-20\% \pm 5\% P_{E_{max}}$ s=5% (40% $P_{E_{max}}$ / Hz), threshold frequency for start/return: 49,8Hz							
Frequency [Hz]:	50,00	49,75	48,80	47,60	48,80	49,75	50,00
P_M [kW]:	N/A	-0,983	0,915	3,315	0,915	-0,983	N/A
P_{E60} [kW]:	-1,038	-1,054	0,885	3,219	0,884	-1,055	-1,081
$\Delta P_{E60}/P_M$ [%]:	N/A	-1,415	-0,612	-1,920	-0,627	-1,441	N/A
1-min mean value [Hz]:	a) 50,00	b) 49,75	c) 48,80	d) 47,60	e) 48,80	f) 49,85	g) 50,00
2. Measurement a) to g): Active power output = $10\% \pm 5\% P_{E_{max}}$ s=5% (40% $P_{E_{max}}$ / Hz), threshold frequency for start/return: 49,8Hz							
Frequency [Hz]:	50,00	49,75	48,80	47,60	48,80	49,85	50,00
P_M [kW]:	N/A	0,735	3,014	5,894	3,014	N/A	N/A
P_{E60} [kW]:	0,616	0,752	3,075	5,819	3,002	0,629	0,628
$\Delta P_{E60}/P_M$ [%]:	N/A	0,277	1,014	-1,254	-0,196	N/A	N/A
3. Measurement a) to g): Active power output = $60\% \pm 5\% P_{E_{max}}$ s=5% (40% $P_{E_{max}}$ / Hz), threshold frequency for start/return: 49,8Hz							
Frequency [Hz]:	50,00	49,75	48,80	47,60	48,80	49,85	50,00
P_M [kW]:	N/A	3,742	6,000	6,000	6,000	N/A	N/A
P_{E60} [kW]:	3,623	3,759	5,982	5,945	5,986	3,633	3,634
$\Delta P_{E60}/P_M$ [%]:	N/A	0,274	-0,300	-0,911	-0,235	N/A	N/A
Limit $\Delta P/P_{1min}$:	$\pm 10\%$ of $P_{E_{max}}$						
Graph of Measurement 1.:							
							

Graph of Measurement 2.:

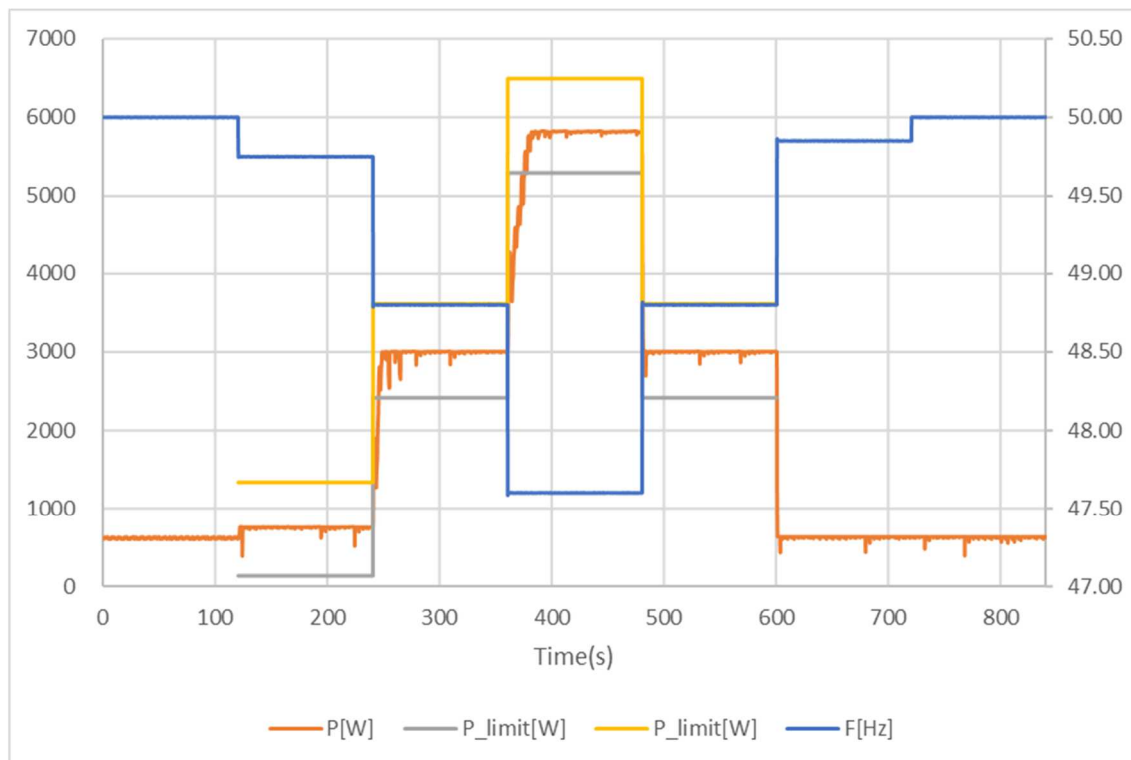

Graph of Measurement 3.:

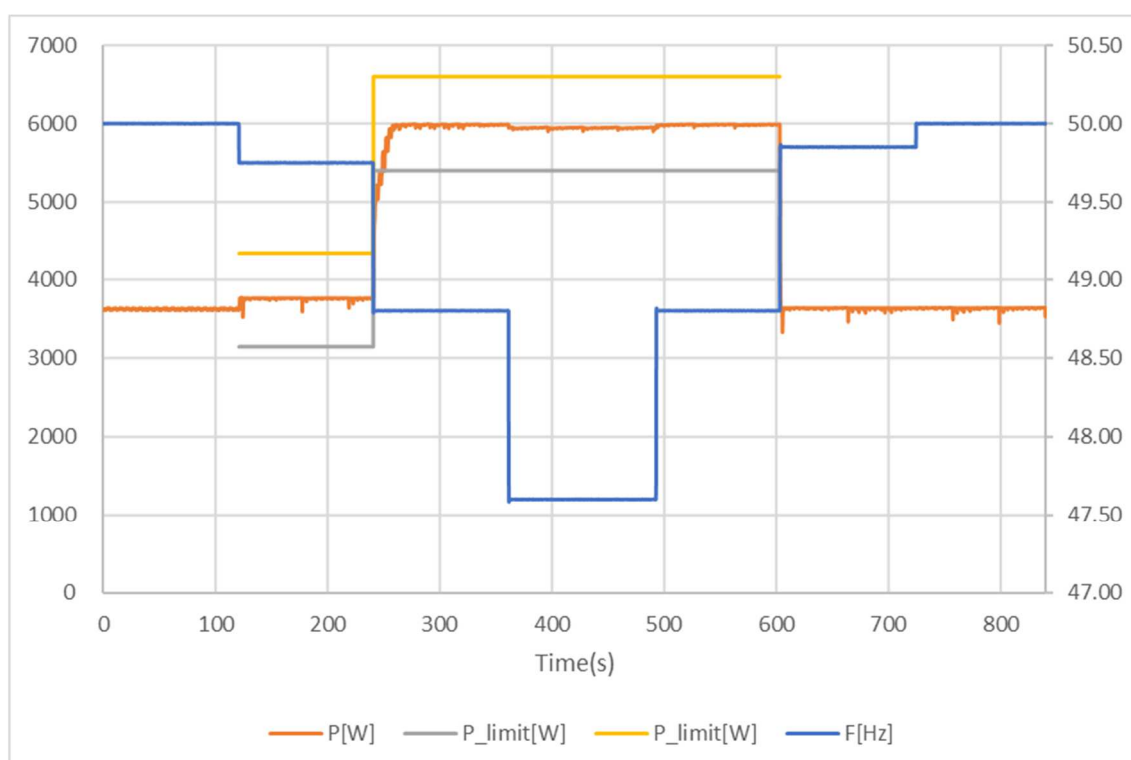

Test:

The test method refer to clause 5.4.7 of VDE V 0124-100:2019-02 (Draft)

All generating units must increase the currently generated available active power PA with a gradient of 40% P_{Emax} per Hertz ($s = 5\%$) up to their technically possible maximum value at frequencies below 49,8 Hz. The maximum value is determined by the current primary energy supply as well as the currently usable storage capacity.

Power reductions, which serve to protect equipment, are also permitted at underfrequency.

While grid frequency is over frequency protection (Ex. $f < 47,5$ Hz), the generating units shall be disconnected from the power supply when supplying energy.

It follows that generating units and memory also in the frequency range between 49,8 Hz and 47,5 Hz or 47,8 Hz with respect to their maximum possible active power feed permanently on the frequency characteristic up and down move („driving on the curve“)

Assessment criterion:

The generating plant shall be capable of activating active power response to under frequency as fast as technically feasible with an intrinsic dead time that shall be as short as possible with a maximum of 2 s and with a step response time of maximum 30 s.

After settling time, the delivered active power should deviate from the nominal value by less than $\pm 10\%$ P_{Emax} .

Note:

The test method refer to clause 5.4.4 of VDE V 0124-100:2019-02 (Draft).

The tests had been performed on the HYD 6000-EP is valid for the HYD 5500-EP, HYD 5000-EP, HYD 4600-EP, HYD 4000-EP, HYD 3680-EP and HYD 3000-EP, since it is identical in hardware and software construction except output power derated by software.

The test results refer to the test report "PVTR200917N016" issued by Bureau Veritas Shenzhen Co., Ltd. Dongguan Branch, dated on 2021.01.20.

EN 50549-1:2019: Power response to voltage variations and voltage changes

Clause	Test requirement	Test procedure according standard	Result
4.7.2.2	Capabilities	--	P
4.7.2.3.2	Fix control modes (<u>cos ϕ setpoint mode</u>)	FGW TG3, Revision 25, clause 4.2.2	P
4.7.2.3.2	Fix control modes (<u>Q setpoint mode, 48,43%</u>)	EN 50438:2013, Annex D.3.4.2.1	P
4.7.2.2	Q Response time	CEI 0-21:2019-04, Annex B.1.2.4	P
4.7.2.3.3	Voltage related control modes (Q (U) controls)	VDE AR 4105:2018-05, clause 5.7.2.4.	N/A
4.7.2.3.4	Power related control modes (cos ϕ (P) curve)	VDE V 0124-100:2012, clause 5.3.6.4	P
4.7.3	Voltage related active power reduction (P(U) function)	CEI 0-21:2019-04, Annex B.1.3.1	P

4.7.2	Voltage support by reactive power	P
4.7.2.2	Capabilities	
4.7.2.3.2	Fix control modes (cos φ setpoint mode)	

Test result: HYD 6000-EP

PF = 0,9 / Inductive reactive power supply

Rating power [%]	Active power [kW]	Reactive power [kVar]	Power factor [cos φ]	DC power [kW]
10%	0,613	-0,293	0,9024	0,634
20%	1,223	-0,592	0,9002	1,252
30%	1,829	-0,888	0,8995	1,867
40%	2,433	-1,203	0,8964	2,484
50%	3,033	-1,459	0,9011	3,098
60%	3,629	-1,784	0,8974	3,713
70%	4,221	-2,052	0,8994	4,324
80%	4,809	-2,373	0,8967	4,936
90%	5,391	-2,622	0,8993	5,542
100%	5,419	-2,636	0,8993	5,575

PF = 0,9 / Capacitive reactive power supply

Rating power [%]	Active power [kW]	Reactive power [kVar]	Power factor [cos φ]	DC power [kW]
10%	0,615	0,286	0,9065	0,634
20%	1,226	0,591	0,9007	1,252
30%	1,833	0,879	0,9017	1,868
40%	2,437	1,199	0,8973	2,484
50%	3,037	1,463	0,9009	3,098
60%	3,635	1,727	0,9032	3,713
70%	4,226	2,037	0,9008	4,324
80%	4,814	2,359	0,8980	4,935
90%	5,395	2,662	0,8968	5,541
100%	5,423	2,672	0,8971	5,574

Cos phi=1 no reactive power supply				
Rating power [%]	Active power [kW]	Reactive power [kVar]	Power factor [cos φ]	DC power [kW]
10%	0,611	0,116	0,9824	0,630
20%	1,224	0,094	0,9970	1,248
30%	1,833	0,073	0,9992	1,865
40%	2,437	0,053	0,9997	2,479
50%	3,039	0,033	0,9999	3,094
60%	3,641	-0,053	0,9999	3,710
70%	4,236	-0,077	0,9998	4,323
80%	4,829	-0,105	0,9998	4,935
90%	5,418	-0,135	0,9997	5,545
100%	6,002	-0,165	0,9996	6,154

Assessment criterion:

The power factor resulting in each of the measurement points between 20 % and 90 % of the nominal power is equal to or lower than 0,90 both in over excited and under excited operation.

The tests had been performed on the HYD 6000-EP is valid for the HYD 5500-EP, HYD 5000-EP, HYD 4600-EP , HYD 4000-EP, HYD 3680-EP and HYD 3000-EP, since it is identical in hardware and software construction except output power derated by software.

The test results refer to the test report "PVTR200917N016" issued by Bureau Veritas Shenzhen Co., Ltd. Dongguan Branch, dated on 2021.01.20.

Diagram

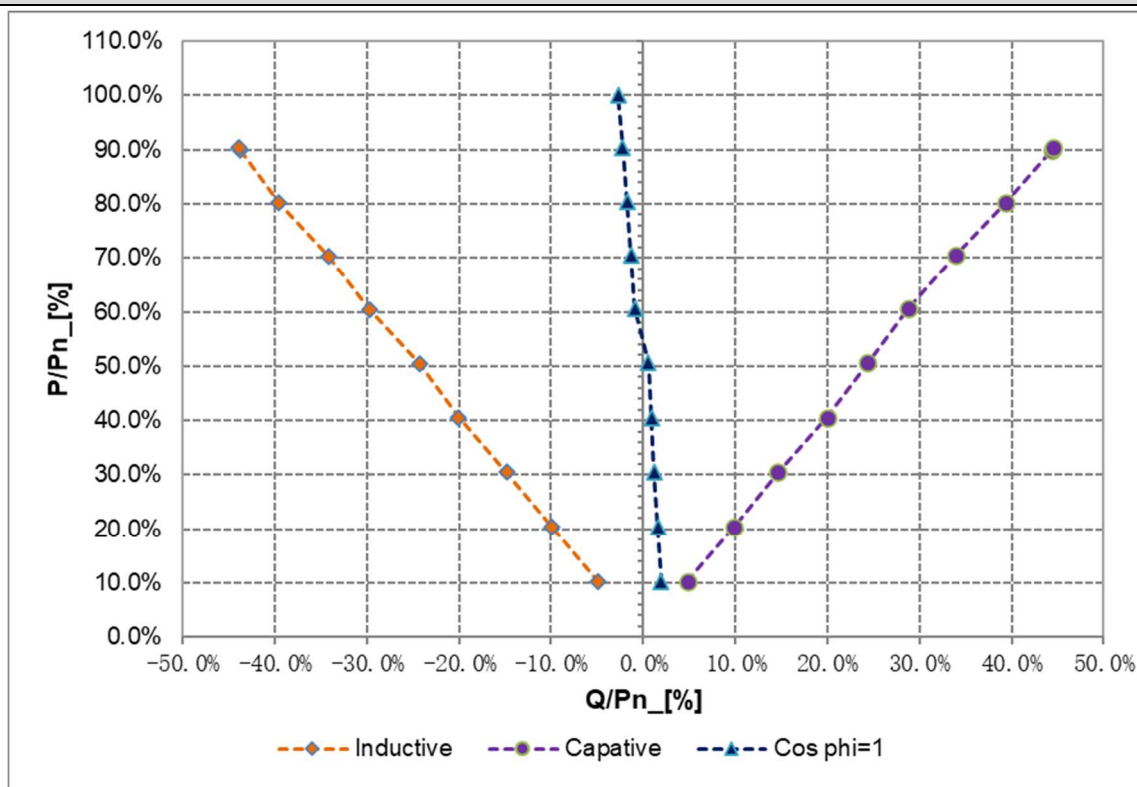

4.7.2 Voltage support by reactive power				P
4.7.2.2 Capabilities				
4.7.2.3.2 Fix control modes (Q setpoint mode, 48,43%)				
Test result: HYD 6000-EP				
Inductive reactive power supply				
Rating power [%]	Active power [kW]	Reactive power [kVar]	Power factor [cos φ]	DC power [kW]
10%	0,556	-2,943	0,1858	0,627
20%	1,178	-2,889	0,3774	1,242
30%	1,792	-2,885	0,5277	1,856
40%	2,405	-2,893	0,6393	2,471
50%	3,011	-2,906	0,7196	3,083
60%	3,615	-2,924	0,7776	3,696
70%	4,215	-2,913	0,8227	4,306
80%	4,812	-2,905	0,8561	4,917
90%	5,403	-2,934	0,8788	5,524
100%	5,696	-2,892	0,8917	5,827
Capacitive reactive power supply				
Rating power [%]	Active power [kW]	Reactive power [kVar]	Power factor [cos φ]	DC power [kW]
10%	0,565	2,885	0,1921	0,626
20%	1,184	2,920	0,3757	1,242
30%	1,798	2,938	0,5220	1,856
40%	2,410	2,946	0,6331	2,471
50%	3,017	2,918	0,7188	3,083
60%	3,622	2,920	0,7785	3,696
70%	4,220	2,922	0,8222	4,306
80%	4,817	2,925	0,8548	4,916
90%	5,408	2,933	0,8790	5,523
100%	5,703	2,899	0,8914	5,832
Cos phi=1 no reactive power supply				
Rating power [%]	Active power [kW]	Reactive power [kVar]	Power factor [cos φ]	DC power [kW]
10%	0,611	0,116	0,9824	0,630
20%	1,224	0,094	0,9970	1,248
30%	1,833	0,073	0,9992	1,865
40%	2,437	0,053	0,9997	2,479
50%	3,039	0,033	0,9999	3,094
60%	3,641	-0,053	0,9999	3,710
70%	4,236	-0,077	0,9998	4,323
80%	4,829	-0,105	0,9998	4,935
90%	5,418	-0,135	0,9997	5,545

100%	6,002	-0,165	0,9996	6,154
------	-------	--------	--------	-------

Assessment criterion:

The power factor resulting in each of the measurement points between 20 % and 90 % of the nominal power is equal to or lower than 0,90 both in over excited and under excited operation,

The test method refer to clause CEI0-21 / EN 50438:2013, Annex D,3,4,2,1,

Generating plants must meet the reactive power requirement regardless of the number of feeding phases under normal steady-state operating conditions in the voltage tolerance band +10%U_n and -15%U_n.

The tests had been performed on the HYD 6000-EP is valid for the HYD 5500-EP, HYD 5000-EP, HYD 4600-EP , HYD 4000-EP, HYD 3680-EP and HYD 3000-EP, since it is identical in hardware and software construction except output power derated by software.

The test results refer to the test report "PVTR200917N016" issued by Bureau Veritas Shenzhen Co., Ltd. Dongguan Branch, dated on 2021.01.20.

Diagram

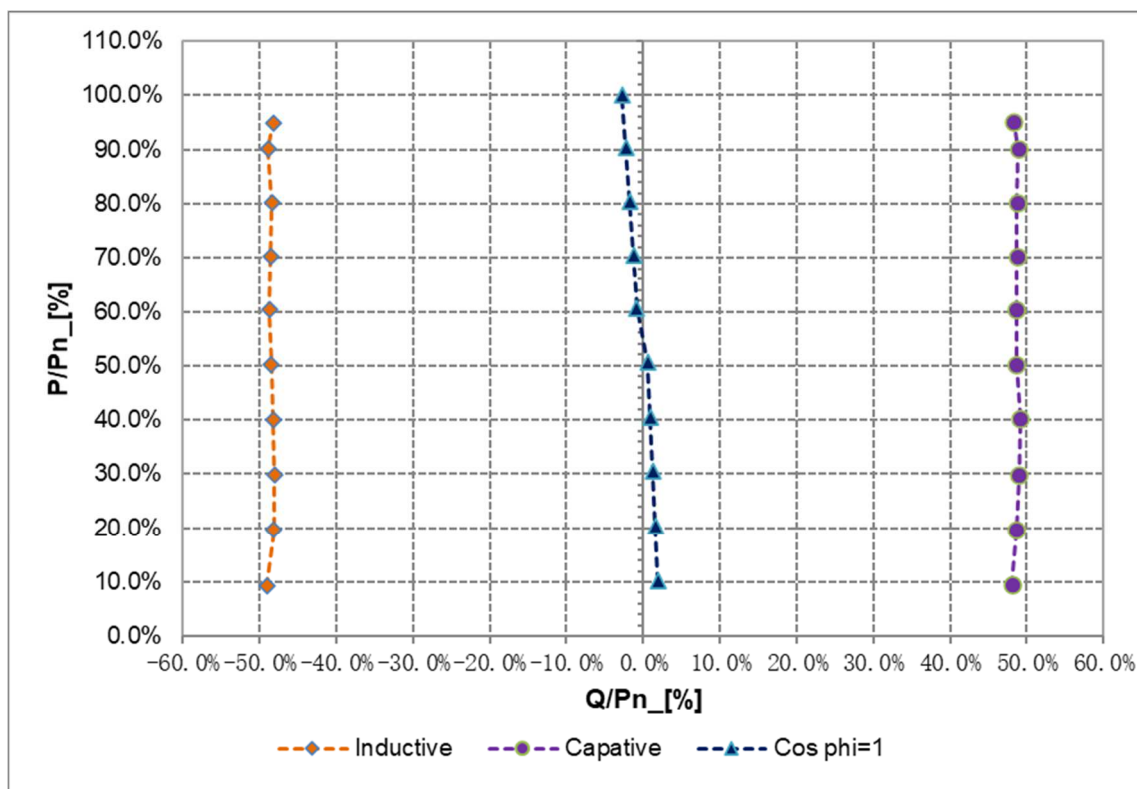

4.7.2.2 Capabilities Q Response time	P
---	----------

Reaction time

Test result:

		Time	Result
1.	Reaction time Q=0 to Qmin (50% test)	1,0	P
2.	Reaction time Qmin to Qmax (50% test)	1,2	P
3.	Reaction time Qmax to Q=0 (50% test)	1,0	P
4.	Reaction time Q=0 to Qmin (100% test)	1,2	P
5.	Reaction time Qmin to Qmax (100% test)	1,4	P
6.	Reaction time Qmax to Q=0 (100% test)	1,0	P

Test result:

Graph 50%Pn

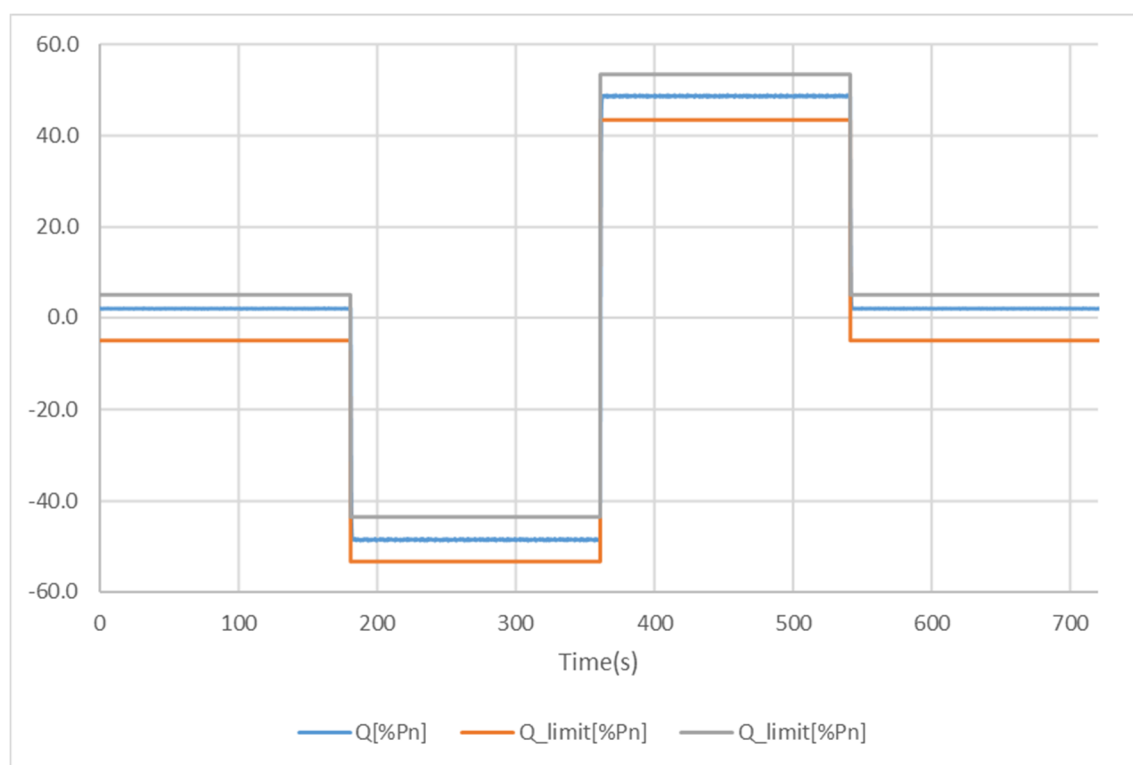

Graph 100%Pn

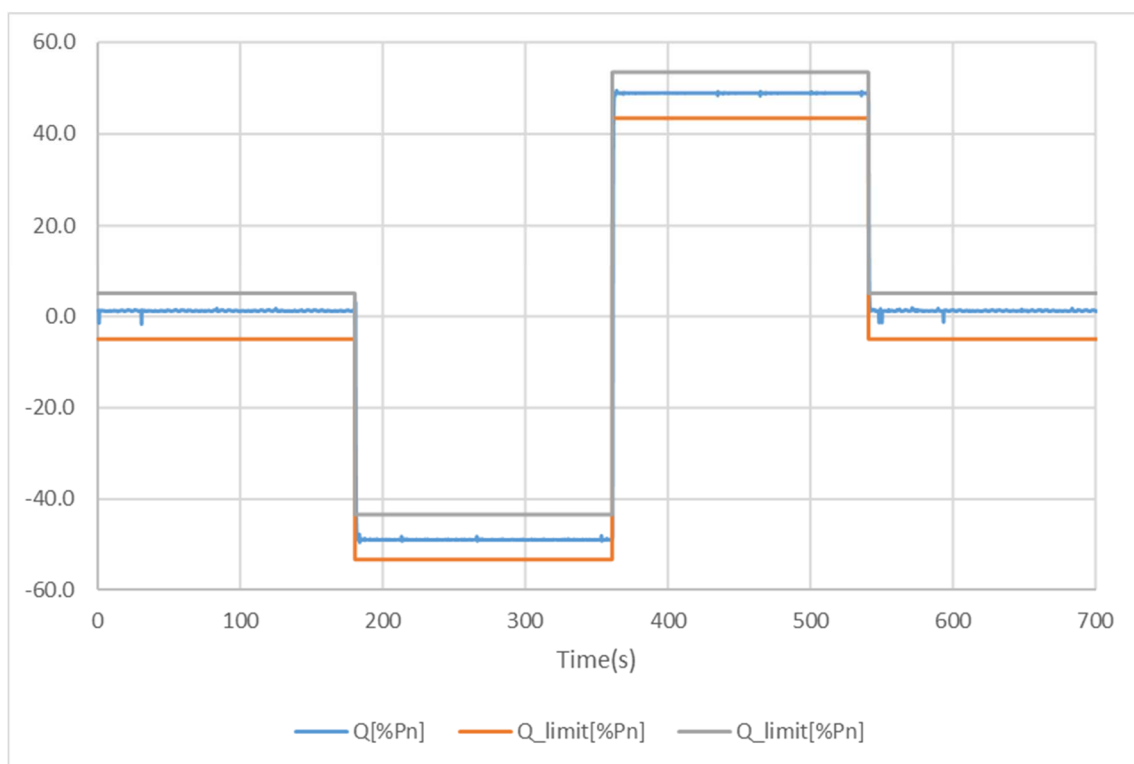

Assessment criterion:

DC source should be set to 50%(test1) and 100%(test2) output power micro-generator.

Starting with Q=0 then $Q_{min} \leq -0,4843 P_n$ to $Q_{max} \geq 0,4843 P_n$, and then back to Q=0 in doing so each point must be kept for at least 2 minute.

The total tolerance is $\Delta Q \leq \pm 5,0\%$ of P_n or $\Delta \cos\phi \leq \pm 0,01$

The maximum response time is 10s.

The tests had been performed on the HYD 6000-EP is valid for the HYD 5500-EP, HYD 5000-EP, HYD 4600-EP, HYD 4000-EP, HYD 3680-EP and HYD 3000-EP, since it is identical in hardware and software construction except output power derated by software.

The test results refer to the test report "PVTR200917N016" issued by Bureau Veritas Shenzhen Co., Ltd. Dongguan Branch, dated on 2021.01.20.

4.7.2.2 Capabilities										P
4.7.2.3.4 Power related Control mode (cos φ (P) curve)										
Test result: HYD 6000-EP										
Test c): supply-dependent PGUs - Accuracy (characteristic curve):										
P _{E30} /P [%]	10	20	30	40	50	60	70	80	90	100
30 s mean value	20% to 100% P _{E30}									
U [V]:	--	230,2	230,2	230,3	230,4	230,4	230,4	230,5	230,6	230,6
P _{E30} [kW]:	--	1,227	1,837	2,442	3,046	3,644	4,235	4,822	5,399	5,528
P _{E30} of P _{E30} [%]:	--	20,45	30,61	40,70	50,76	60,74	70,58	80,36	89,99	92,14
Q _{E30} [kVar]:	--	0,128	0,121	0,115	-0,078	-0,684	-1,190	-1,719	-2,219	-2,401
COS φ _{E30} :	--	0,995	0,998	0,999	1,000	0,983	0,963	0,942	0,925	0,917
COS φ _{setpoint} of P _{E30} :	--	1,000	1,000	1,000	1,000	0,980	0,960	0,940	0,920	0,900
Q _{setpoint} [kVar]:	--	0	0	0	0	-0,725	-1,186	-1,645	-2,116	-2,167
ΔQ/P _{E30} [%]	--	0,017	0,017	0,017	0,017	0,028	0,036	0,043	0,051	0,051
Limit ΔQ:	± 4% P _{E30}									
Test d): supply-dependent PGUs - Dynamic:										
P _{E30} /P _n [%]	100		40		100		75			
30 s mean value	100% to 40% to 100% to 75% P _{E30}									
U [V]:	231,2		230,6		231,1		230,54			
P _{E30} [kW]:	5,517		2,436		5,516		4,526			
P _{E30} of P _{E30} [%]:	91,95		40,60		91,94		75,43			
Q _{E30} [kVar]:	-2,350		0,145		-2,349		-1,403			
S _{E30} [kVA] :	5,997		2,440		5,996		4,738			
COS φ _{E30} :	0,920		0,998		0,920		0,955			

cos φ setpoint of P _{E30} :	0,916	1,000	0,916	0,950
Q _{setpoint} [kVar]:	-2,414	0	-2,414	-1,485
$\Delta Q/P_{E\max}$ [%]	1,076	2,420	1,080	1,370
Limit ΔQ :	$\pm 4\% P_{E\max}$			

Graph of cos φ (P): Test c)

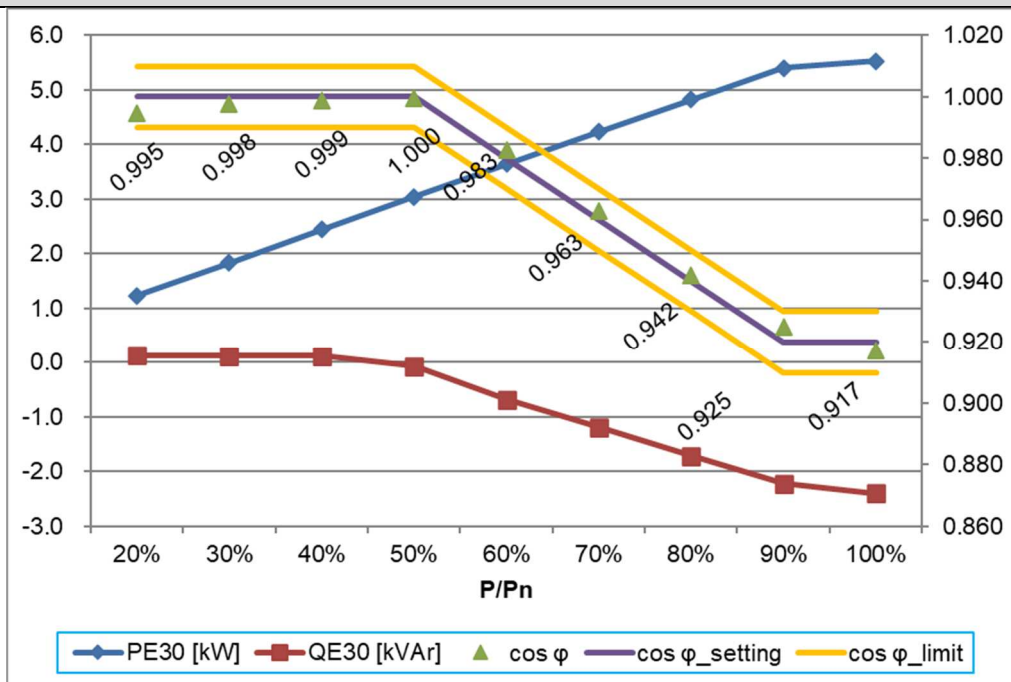

Graph of Test d): 100% to 40% P_{Emax}

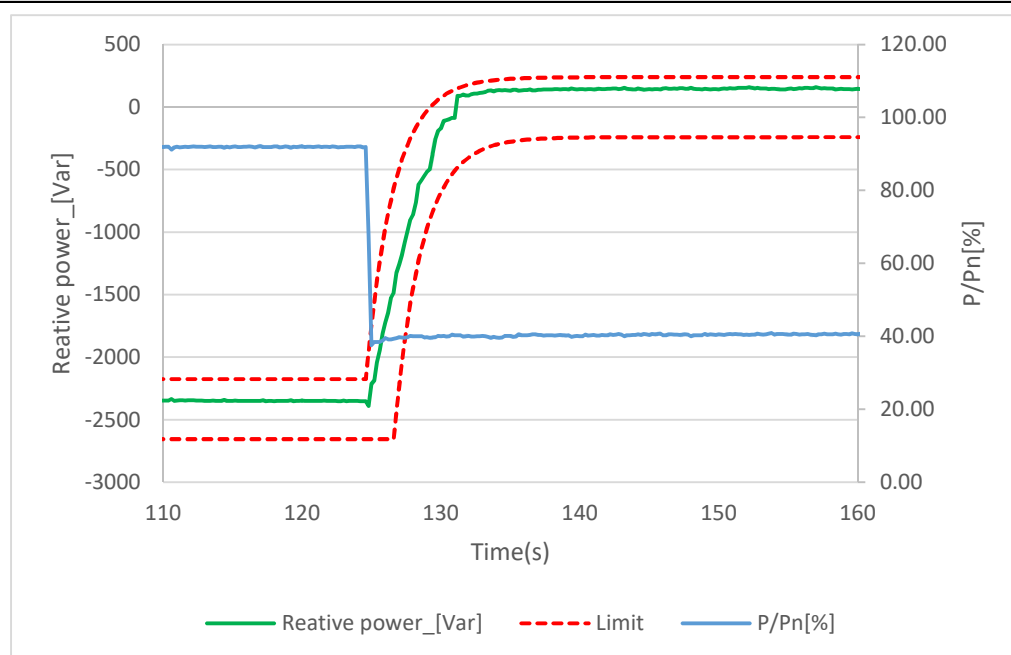

Graph of Test d): 40% to 100% P_{Emax}

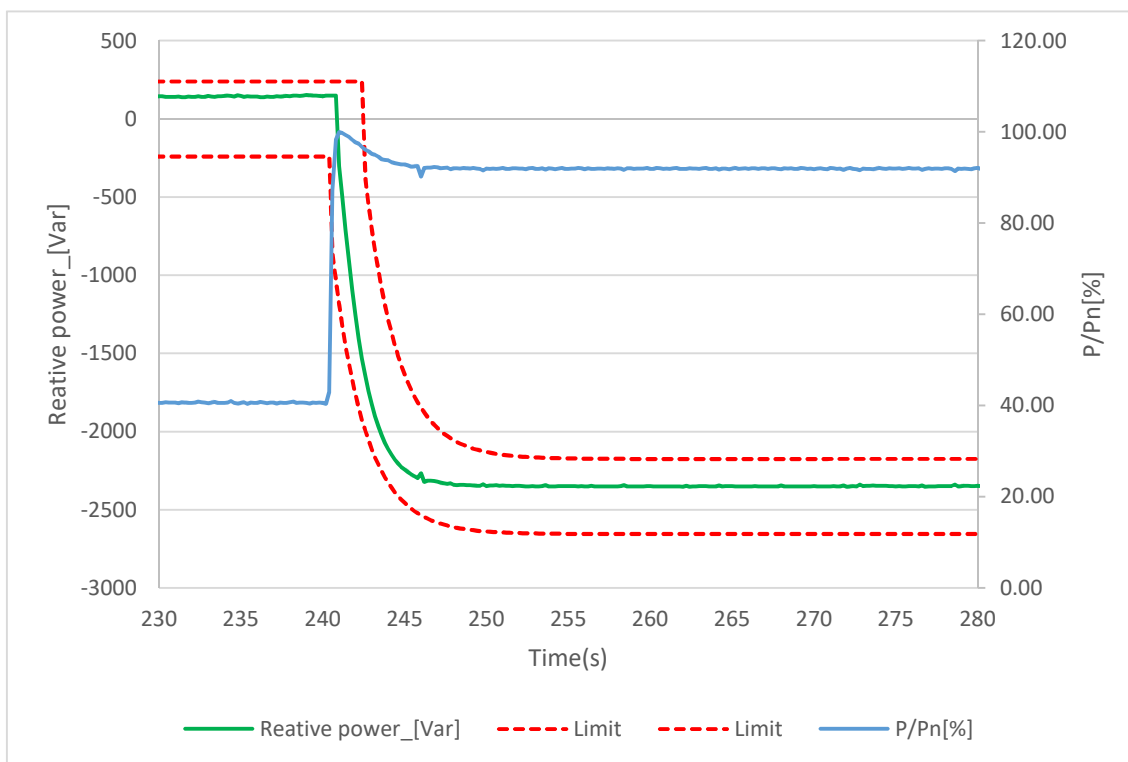

Graph of Test d): 100% to 75% P_{Emax}

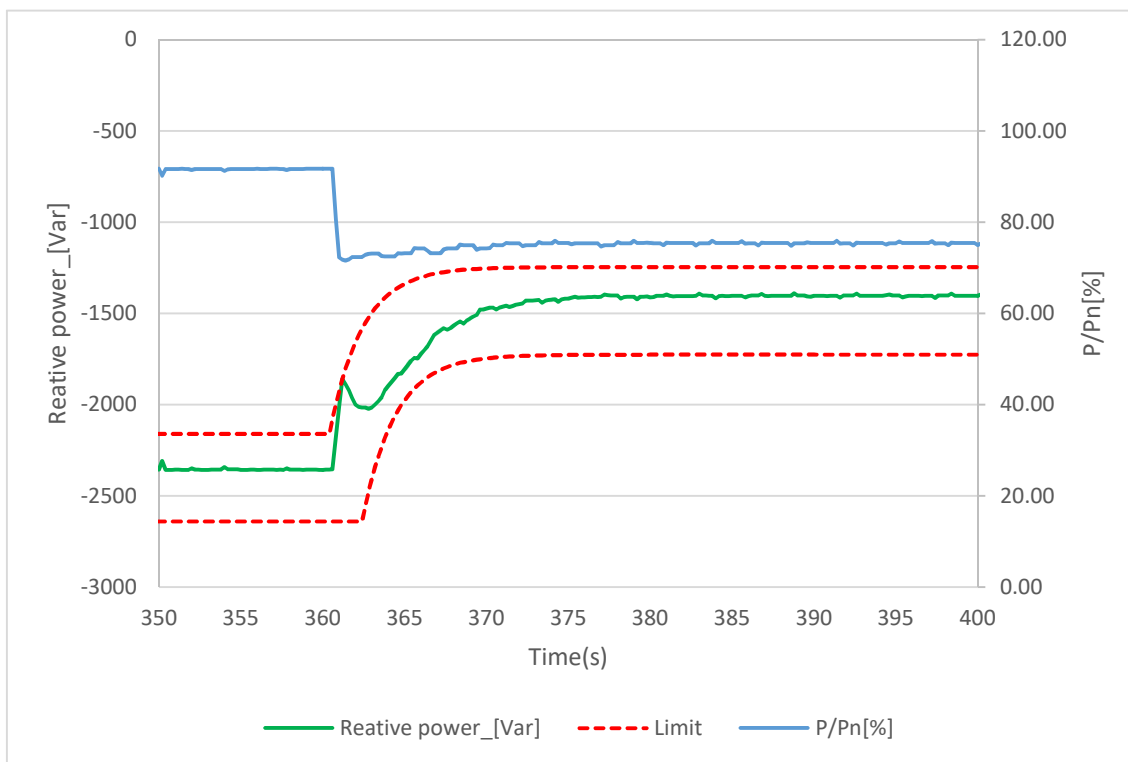

Assessment criterion:

Test 5.4.8.2 a) and c) are passed if the maximum deviation between the reactive power setpoint (calculated from the characteristic) and the reactive power actual value at the generator terminals for all calculated reactive power values is a maximum of $\pm 4.0\%$ relative to $P_{E_{max}}$.

Test 5.4.8.2 (b) is regarded as passed if the PGU demonstrably complies with the performance gradient requirements of VDE-AR-N 4105: 2018-11 in Section 5.7.4.2.

Test 5.4.8.2 d) is passed if the step response of the reactive power in the test steps c) and e) exhibits the PT1 behavior according to VDE-AR-N 4105: 2018-11 Section 5.7.2.5 and for test step d) the power gradient between the Limits of VDE-AR-N 4105: 2018-11 Section 5.7.4.2.

Note:

The tests had been performed on the HYD 6000-EP is valid for the HYD 5500-EP, HYD 5000-EP, HYD 4600-EP, HYD 4000-EP, HYD 3680-EP and HYD 3000-EP, since it is identical in hardware and software construction except output power derated by software.

The test results refer to the test report "PVTR200917N016" issued by Bureau Veritas Shenzhen Co., Ltd. Dongguan Branch, dated on 2021.01.20.

4.7.3 Voltage related active power reduction (P(U) function)		P
Test:		
5-min mean value / P / P _n [%]	100% to 20%	
Settling time [s]:		
	254s	
P_{E60} [%]:		
	20%	
ΔP_{E60}/P_{Setpoint} [%]:		
	20 % or less of P _{E_{max}}	
Limit settling time:		
	300s	
<p>Test:</p> <p>a) Set the voltage to 2% V_n lower than the activation threshold stated by the manufacturer.</p> <p>b) Set the voltage to 112%V_n, The inverter now has to reduce its output power to value lower than 20%P_n within 5min.</p> <p>c) Set the voltage back to 2%V_n lower than the activation threshold, Check that the active power will return to the value consistent with the power available from the primary source or simulated.</p>		
<p>Assessment criterion:</p> <p>for adjustable PGUs:</p> <ul style="list-style-type: none"> - no network disconnection - the active power value does not exceed the setpoint of 20% P_{E_{max}} - the setting time determined is equal or less than 600s 		

Graph:

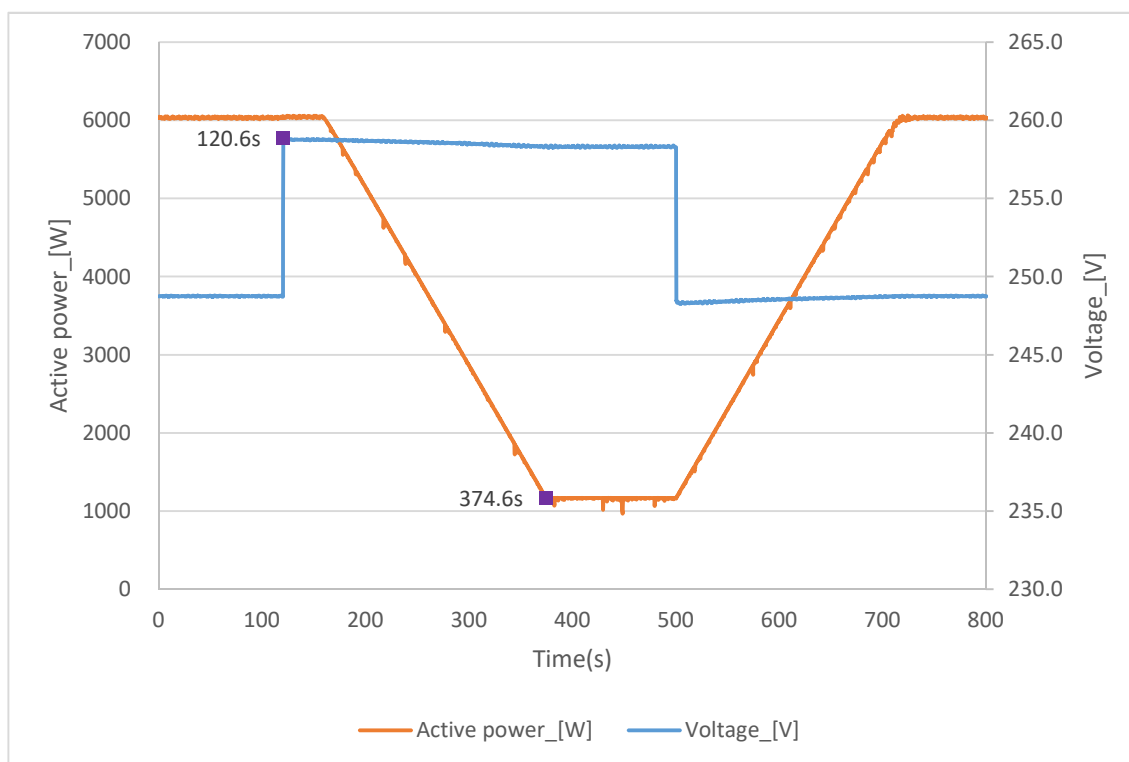

Note:

The tests had been performed on the HYD 6000-EP is valid for the HYD 5500-EP, HYD 5000-EP, HYD 4600-EP, HYD 4000-EP, HYD 3680-EP and HYD 3000-EP, since it is identical in hardware and software construction except output power derated by software.

The test results refer to the test report "PVTR200917N016" issued by Bureau Veritas Shenzhen Co., Ltd. Dongguan Branch, dated on 2021.01.20.

EN 50549-1:2019: Power quality

Clause	Test requirement	Test procedure according standard	Result
4.8	EMC and power quality	--	P
	Harmonic current emission	EN 61000-3-2, EN 61000-3-12	P
	Harmonic current emission	EN 61000-4-7	P
	Switching operations	IEC 61400-21	P
	Voltage fluctuation and flicker	EN 61000-3-3, EN 61000-3-11	P
	Flicker and voltage fluctuations	IEC 61400-21	P
	DC injection	EN 50438, Annex D,3,10	P
	Immunity to voltage dips and short interruptions	G59/3-4:2018-05, clause 13.8.4.5	P
	Unbalance	BDEW TG3, Revision 25, clause 4.3.5	N/A

4.8 EMC and power quality Harmonic current emission (EN 61000-3-2)				P
Test result: HYD 3000-EP				
Watts [KW]		3,022		
Vrms [V]		230,41		
Arms [A]		13,13		
Frequency [Hz]		50		
THD50* (100% output power)		1,446		
Harmonic order n	Current Magnitude [A] at 100% rated output power	% of Fundamental	Phase	Harmonic Current Limits [A]
1st	13,126	99,947	Single Phase	--
2nd	0,004	0,029	Single Phase	1,080
3rd	0,162	1,235	Single Phase	2,300
4th	0,002	0,012	Single Phase	0,430
5th	0,077	0,583	Single Phase	1,140
6th	0,002	0,015	Single Phase	0,300
7th	0,039	0,300	Single Phase	0,770
8th	0,001	0,011	Single Phase	0,230
9th	0,021	0,160	Single Phase	0,400
10th	0,001	0,010	Single Phase	0,184
11th	0,010	0,079	Single Phase	0,330
12th	0,001	0,009	Single Phase	0,153
13th	0,007	0,055	Single Phase	0,210
14th	0,001	0,008	Single Phase	0,131
15th	0,006	0,048	Single Phase	0,150
16th	0,001	0,007	Single Phase	0,115
17th	0,009	0,065	Single Phase	0,132
18th	0,001	0,007	Single Phase	0,102
19th	0,009	0,072	Single Phase	0,118
20th	0,001	0,007	Single Phase	0,092
21th	0,011	0,080	Single Phase	0,107
22th	0,001	0,006	Single Phase	0,084
23th	0,011	0,087	Single Phase	0,098
24th	0,001	0,006	Single Phase	0,077
25th	0,011	0,085	Single Phase	0,090
26th	0,001	0,005	Single Phase	0,071
27th	0,011	0,087	Single Phase	0,083
28th	0,001	0,005	Single Phase	0,066
29th	0,011	0,082	Single Phase	0,078
30th	0,001	0,006	Single Phase	0,061
31th	0,011	0,082	Single Phase	0,073
32th	0,001	0,005	Single Phase	0,058
33th	0,011	0,081	Single Phase	0,068
34th	0,001	0,006	Single Phase	0,054
35th	0,010	0,075	Single Phase	0,064
36th	0,001	0,006	Single Phase	0,051
37th	0,010	0,075	Single Phase	0,061
38th	0,001	0,006	Single Phase	0,048
39th	0,010	0,076	Single Phase	0,058
40th	0,001	0,005	Single Phase	0,046

Test result: HYD 6000-EP				
Watts [KW]		6,034		
Vrms [V]		230,70		
Arms [A]		26,17		
Frequency [Hz]		50		
THD50* (100% output power)		0,965		
Harmonic order n	Current Magnitude [A] at 100% rated output power	% of Fundamental	Phase	Harmonic Current Limits [%]
1st	26,157	99,961	Single Phase	--
2nd	0,007	0,026	Single Phase	8,000
3rd	0,207	0,792	Single Phase	21,600
4th	0,002	0,007	Single Phase	4,000
5th	0,109	0,417	Single Phase	10,700
6th	0,003	0,013	Single Phase	2,667
7th	0,067	0,255	Single Phase	7,200
8th	0,003	0,012	Single Phase	2,000
9th	0,042	0,159	Single Phase	3,800
10th	0,003	0,012	Single Phase	1,600
11th	0,020	0,077	Single Phase	3,100
12th	0,003	0,010	Single Phase	1,333
13th	0,012	0,044	Single Phase	2,000
14th	0,002	0,009	Single Phase	8,000
15th	0,013	0,050	Single Phase	N/A
16th	0,002	0,008	Single Phase	N/A
17th	0,017	0,065	Single Phase	N/A
18th	0,002	0,007	Single Phase	N/A
19th	0,017	0,064	Single Phase	N/A
20th	0,001	0,005	Single Phase	N/A
21th	0,015	0,059	Single Phase	N/A
22th	0,001	0,005	Single Phase	N/A
23th	0,013	0,049	Single Phase	N/A
24th	0,001	0,005	Single Phase	N/A
25th	0,011	0,044	Single Phase	N/A
26th	0,001	0,004	Single Phase	N/A
27th	0,012	0,044	Single Phase	N/A
28th	0,001	0,006	Single Phase	N/A
29th	0,010	0,040	Single Phase	N/A
30th	0,001	0,005	Single Phase	N/A
31th	0,010	0,039	Single Phase	N/A
32th	0,001	0,004	Single Phase	N/A
33th	0,009	0,036	Single Phase	N/A
34th	0,001	0,004	Single Phase	N/A
35th	0,008	0,029	Single Phase	N/A
36th	0,001	0,005	Single Phase	N/A
37th	0,007	0,027	Single Phase	N/A
38th	0,001	0,005	Single Phase	N/A
39th	0,007	0,028	Single Phase	N/A
40th	0,001	0,004	Single Phase	N/A

Note:

The tests should be based on the limits of the EN 61000-3-12 for more than 16A.

The tests had been performed on the HYD 6000-EP and HYD 3000-EP are valid for the HYD 5500-EP, HYD 5000-EP, HYD 4600-EP, HYD 4000-EP and HYD 3680-EP, since it is identical in hardware and software construction except output power derated by software.

4.8 EMC and power quality Harmonic current emission (EN 61000-4-7)											P
The currents of the interharmonics to 2 kHz must be measured in accordance with DIN EN 61000-4-7 (VDE 0817-4-7), Annex A, The measurements of higher-frequency harmonic currents between 2 kHz and 9 kHz must be conducted in line with DIN EN 61000-4-7 (VDE 0847-4-7), Annex B.											
Test result: HYD 3000-EP											
Harmonics											
P/P _n [%]	0	10	20	30	40	50	60	70	80	90	100
Order	I [%]	I [%]	I [%]	I [%]	I [%]	I [%]	I [%]	I [%]	I [%]	I [%]	I [%]
1	2,970	10,467	20,579	30,726	40,816	50,853	60,856	70,786	80,677	90,505	100,260
2	0,018	0,025	0,024	0,018	0,019	0,019	0,018	0,016	0,015	0,017	0,044
3	0,476	0,608	0,618	0,625	0,635	0,638	0,640	0,645	0,651	0,692	0,809
4	0,016	0,011	0,011	0,009	0,009	0,010	0,011	0,011	0,013	0,012	0,015
5	0,273	0,303	0,299	0,294	0,292	0,291	0,287	0,277	0,270	0,305	0,399
6	0,012	0,008	0,009	0,007	0,007	0,008	0,008	0,008	0,007	0,013	0,021
7	0,180	0,168	0,155	0,154	0,150	0,148	0,139	0,132	0,128	0,168	0,242
8	0,008	0,008	0,008	0,007	0,007	0,008	0,008	0,008	0,007	0,009	0,010
9	0,110	0,099	0,093	0,090	0,085	0,079	0,074	0,072	0,074	0,114	0,158
10	0,007	0,008	0,008	0,007	0,007	0,007	0,008	0,008	0,007	0,011	0,012
11	0,076	0,066	0,061	0,050	0,044	0,039	0,039	0,049	0,063	0,077	0,076
12	0,007	0,007	0,007	0,006	0,007	0,007	0,007	0,007	0,008	0,010	0,012
13	0,064	0,055	0,044	0,030	0,027	0,029	0,038	0,056	0,074	0,069	0,047
14	0,007	0,006	0,007	0,006	0,006	0,007	0,007	0,007	0,008	0,010	0,010
15	0,052	0,051	0,035	0,027	0,023	0,029	0,047	0,065	0,082	0,070	0,059
16	0,006	0,006	0,006	0,006	0,006	0,006	0,007	0,007	0,007	0,011	0,008
17	0,057	0,053	0,036	0,028	0,026	0,040	0,058	0,074	0,089	0,077	0,076
18	0,006	0,005	0,006	0,005	0,006	0,006	0,006	0,006	0,006	0,011	0,009
19	0,057	0,053	0,034	0,027	0,032	0,046	0,061	0,076	0,087	0,079	0,074
20	0,006	0,005	0,005	0,005	0,005	0,006	0,006	0,006	0,006	0,010	0,008
21	0,062	0,055	0,035	0,029	0,035	0,050	0,066	0,079	0,088	0,081	0,069
22	0,006	0,005	0,005	0,005	0,005	0,005	0,005	0,006	0,006	0,009	0,008
23	0,065	0,055	0,035	0,031	0,039	0,055	0,068	0,078	0,084	0,077	0,058
24	0,006	0,005	0,005	0,004	0,005	0,005	0,006	0,006	0,007	0,009	0,008
25	0,067	0,053	0,033	0,032	0,039	0,055	0,065	0,074	0,079	0,072	0,054
26	0,006	0,004	0,004	0,004	0,004	0,005	0,005	0,006	0,006	0,007	0,007
27	0,066	0,053	0,035	0,035	0,043	0,057	0,067	0,076	0,079	0,069	0,053
28	0,006	0,005	0,004	0,004	0,005	0,005	0,006	0,006	0,006	0,008	0,008
29	0,064	0,048	0,031	0,033	0,041	0,054	0,066	0,072	0,073	0,062	0,049
30	0,006	0,004	0,004	0,004	0,005	0,005	0,005	0,006	0,006	0,007	0,007
31	0,060	0,048	0,032	0,033	0,042	0,056	0,065	0,070	0,070	0,060	0,048
32	0,006	0,005	0,004	0,004	0,005	0,005	0,005	0,005	0,006	0,007	0,007
33	0,059	0,044	0,031	0,033	0,041	0,055	0,064	0,068	0,068	0,058	0,045
34	0,007	0,005	0,004	0,004	0,005	0,005	0,006	0,006	0,006	0,008	0,007
35	0,050	0,040	0,028	0,030	0,040	0,054	0,062	0,065	0,063	0,053	0,037
36	0,007	0,005	0,005	0,005	0,005	0,005	0,006	0,006	0,006	0,008	0,008

37	0,049	0,037	0,026	0,029	0,038	0,052	0,061	0,064	0,062	0,051	0,035
38	0,008	0,005	0,005	0,005	0,005	0,005	0,005	0,006	0,006	0,007	0,007
39	0,047	0,040	0,028	0,030	0,040	0,055	0,062	0,063	0,061	0,050	0,036
40	0,008	0,006	0,006	0,006	0,006	0,006	0,006	0,006	0,006	0,007	0,008

Interharmonics											
P/P _n [%]	0	10	20	30	40	50	60	70	80	90	100
f [Hz]	I [%]	I [%]	I [%]	I [%]	I [%]	I [%]	I [%]	I [%]	I [%]	I [%]	I [%]
75	0,050	0,066	0,068	0,041	0,041	0,042	0,043	0,044	0,043	0,043	0,058
125	0,025	0,023	0,022	0,015	0,015	0,017	0,017	0,015	0,015	0,014	0,018
175	0,024	0,014	0,015	0,012	0,011	0,012	0,013	0,012	0,011	0,011	0,014
225	0,019	0,013	0,014	0,011	0,011	0,011	0,012	0,011	0,011	0,011	0,012
275	0,018	0,011	0,013	0,011	0,011	0,011	0,012	0,012	0,011	0,011	0,012
325	0,017	0,012	0,013	0,011	0,012	0,012	0,012	0,012	0,012	0,012	0,013
375	0,012	0,012	0,013	0,011	0,012	0,012	0,013	0,012	0,012	0,012	0,013
425	0,011	0,012	0,013	0,012	0,012	0,012	0,013	0,012	0,012	0,013	0,013
475	0,010	0,011	0,012	0,011	0,012	0,012	0,013	0,013	0,013	0,013	0,013
525	0,010	0,011	0,011	0,011	0,011	0,012	0,013	0,013	0,012	0,013	0,013
575	0,010	0,010	0,011	0,011	0,011	0,012	0,012	0,012	0,013	0,013	0,013
625	0,010	0,010	0,010	0,010	0,011	0,011	0,012	0,012	0,012	0,013	0,013
675	0,010	0,009	0,010	0,010	0,010	0,011	0,012	0,012	0,013	0,013	0,013
725	0,010	0,009	0,009	0,009	0,010	0,011	0,011	0,012	0,012	0,013	0,013
775	0,010	0,009	0,009	0,009	0,010	0,010	0,011	0,012	0,012	0,013	0,013
825	0,010	0,008	0,008	0,009	0,009	0,010	0,011	0,011	0,012	0,013	0,013
875	0,009	0,008	0,008	0,008	0,009	0,010	0,011	0,011	0,012	0,012	0,013
925	0,009	0,008	0,008	0,008	0,009	0,009	0,010	0,011	0,011	0,012	0,013
975	0,012	0,010	0,010	0,010	0,011	0,012	0,012	0,013	0,014	0,014	0,015
1025	0,009	0,007	0,007	0,007	0,008	0,009	0,009	0,010	0,011	0,012	0,012
1075	0,013	0,010	0,010	0,011	0,011	0,012	0,012	0,013	0,014	0,015	0,017
1125	0,009	0,007	0,007	0,007	0,008	0,008	0,009	0,010	0,011	0,012	0,013
1175	0,009	0,007	0,007	0,007	0,007	0,008	0,009	0,010	0,011	0,012	0,013
1225	0,009	0,007	0,007	0,007	0,007	0,008	0,009	0,010	0,011	0,012	0,013
1275	0,009	0,007	0,007	0,007	0,007	0,008	0,009	0,010	0,011	0,012	0,013
1325	0,009	0,007	0,007	0,007	0,007	0,008	0,009	0,009	0,010	0,012	0,013
1375	0,009	0,007	0,007	0,007	0,007	0,008	0,009	0,009	0,010	0,012	0,013
1425	0,009	0,007	0,007	0,007	0,007	0,008	0,008	0,009	0,010	0,012	0,013
1475	0,009	0,007	0,007	0,007	0,007	0,008	0,008	0,009	0,010	0,011	0,013
1525	0,009	0,007	0,007	0,007	0,007	0,007	0,008	0,009	0,010	0,011	0,012
1575	0,009	0,007	0,007	0,007	0,007	0,008	0,008	0,009	0,010	0,011	0,013
1625	0,009	0,007	0,007	0,007	0,007	0,007	0,008	0,009	0,010	0,011	0,012
1675	0,010	0,008	0,007	0,007	0,008	0,008	0,009	0,009	0,010	0,011	0,013
1725	0,009	0,007	0,007	0,007	0,007	0,007	0,008	0,009	0,010	0,011	0,012
1775	0,011	0,008	0,008	0,008	0,008	0,008	0,009	0,009	0,010	0,011	0,012
1825	0,010	0,007	0,007	0,007	0,007	0,008	0,008	0,009	0,010	0,010	0,012
1875	0,010	0,008	0,007	0,007	0,007	0,008	0,008	0,009	0,010	0,011	0,011
1925	0,010	0,008	0,007	0,007	0,007	0,008	0,008	0,009	0,010	0,010	0,011

1975	0,011	0,008	0,008	0,007	0,007	0,008	0,008	0,009	0,010	0,011	0,012
------	-------	-------	-------	-------	-------	-------	-------	-------	-------	-------	-------

Higher Frequencies											
P/P _n [%]	0	10	20	30	40	50	60	70	80	90	100
f [kHz]	I [%]	I [%]	I [%]	I [%]	I [%]	I [%]	I [%]	I [%]	I [%]	I [%]	I [%]
2,1	0,064	0,052	0,037	0,040	0,055	0,073	0,084	0,085	0,079	0,064	0,046
2,3	0,062	0,049	0,035	0,038	0,054	0,074	0,084	0,084	0,078	0,061	0,042
2,5	0,072	0,061	0,049	0,049	0,062	0,078	0,085	0,083	0,079	0,064	0,051
2,7	0,065	0,052	0,038	0,041	0,057	0,074	0,080	0,078	0,071	0,056	0,037
2,9	0,060	0,050	0,036	0,038	0,054	0,070	0,076	0,071	0,063	0,048	0,034
3,1	0,058	0,048	0,038	0,040	0,056	0,069	0,073	0,069	0,062	0,048	0,034
3,3	0,051	0,044	0,034	0,036	0,048	0,060	0,064	0,060	0,053	0,041	0,030
3,5	0,046	0,041	0,033	0,035	0,045	0,053	0,055	0,051	0,044	0,035	0,027
3,7	0,043	0,039	0,033	0,035	0,044	0,050	0,052	0,049	0,043	0,034	0,028
3,9	0,037	0,033	0,029	0,032	0,038	0,043	0,044	0,042	0,037	0,031	0,026
4,1	0,031	0,027	0,024	0,026	0,032	0,036	0,038	0,036	0,032	0,027	0,023
4,3	0,027	0,023	0,021	0,023	0,026	0,029	0,031	0,030	0,027	0,023	0,021
4,5	0,023	0,021	0,019	0,020	0,022	0,025	0,026	0,025	0,023	0,022	0,021
4,7	0,036	0,035	0,033	0,033	0,033	0,034	0,035	0,035	0,034	0,033	0,033
4,9	0,035	0,033	0,032	0,032	0,032	0,033	0,033	0,033	0,033	0,032	0,032
5,1	0,016	0,015	0,014	0,015	0,016	0,018	0,019	0,018	0,017	0,016	0,016
5,3	0,015	0,014	0,013	0,014	0,015	0,016	0,016	0,016	0,015	0,015	0,014
5,5	0,014	0,013	0,013	0,013	0,014	0,014	0,015	0,014	0,014	0,014	0,014
5,7	0,019	0,019	0,018	0,018	0,018	0,018	0,018	0,018	0,018	0,018	0,019
5,9	0,018	0,018	0,017	0,017	0,016	0,016	0,017	0,017	0,017	0,017	0,018
6,1	0,011	0,010	0,010	0,010	0,010	0,010	0,011	0,011	0,011	0,012	0,012
6,3	0,010	0,010	0,010	0,009	0,009	0,009	0,010	0,011	0,011	0,011	0,011
6,5	0,010	0,010	0,010	0,009	0,009	0,009	0,010	0,011	0,011	0,011	0,011
6,7	0,010	0,010	0,009	0,009	0,009	0,009	0,010	0,010	0,011	0,011	0,011
6,9	0,011	0,011	0,010	0,010	0,010	0,010	0,010	0,011	0,011	0,011	0,012
7,1	0,010	0,010	0,009	0,009	0,008	0,008	0,009	0,010	0,010	0,010	0,010
7,3	0,010	0,009	0,009	0,009	0,008	0,008	0,009	0,010	0,010	0,010	0,010
7,5	0,010	0,010	0,009	0,009	0,008	0,008	0,009	0,010	0,010	0,010	0,010
7,7	0,009	0,009	0,009	0,008	0,008	0,008	0,009	0,009	0,010	0,010	0,010
7,9	0,009	0,009	0,009	0,008	0,008	0,008	0,008	0,009	0,009	0,009	0,010
8,1	0,009	0,008	0,008	0,007	0,007	0,007	0,008	0,008	0,009	0,009	0,009
8,3	0,008	0,008	0,008	0,007	0,007	0,007	0,008	0,008	0,009	0,009	0,009
8,5	0,008	0,008	0,008	0,007	0,007	0,007	0,008	0,008	0,009	0,009	0,009
8,7	0,008	0,008	0,007	0,007	0,007	0,007	0,008	0,008	0,008	0,008	0,008
8,9	0,007	0,007	0,007	0,006	0,006	0,007	0,007	0,007	0,008	0,008	0,008

HYD 6000-EP											
P/P _n [%]	0	10	20	30	40	50	60	70	80	90	100
Order	I [%]	I [%]	I [%]	I [%]	I [%]	I [%]	I [%]	I [%]	I [%]	I [%]	I [%]
1	5,191	10,068	20,081	29,772	39,597	49,581	59,142	70,166	79,861	89,617	98,279
2	0,084	0,152	0,147	0,159	0,187	0,222	0,216	0,209	0,234	0,259	0,266
3	0,505	0,580	0,593	0,600	0,607	0,611	0,624	0,632	0,662	0,671	0,710
4	0,056	0,084	0,076	0,069	0,073	0,072	0,083	0,075	0,076	0,088	0,092
5	0,264	0,304	0,291	0,286	0,288	0,290	0,293	0,287	0,277	0,265	0,244
6	0,029	0,037	0,062	0,068	0,073	0,072	0,078	0,073	0,073	0,078	0,081
7	0,171	0,179	0,152	0,154	0,151	0,155	0,148	0,138	0,146	0,134	0,144
8	0,031	0,063	0,044	0,053	0,062	0,075	0,071	0,071	0,120	0,114	0,151
9	0,104	0,112	0,125	0,122	0,121	0,111	0,129	0,136	0,120	0,176	0,186
10	0,017	0,025	0,065	0,064	0,068	0,062	0,084	0,097	0,075	0,131	0,131
11	0,079	0,084	0,080	0,070	0,075	0,090	0,083	0,090	0,151	0,150	0,203
12	0,024	0,029	0,023	0,025	0,032	0,043	0,038	0,040	0,072	0,060	0,078
13	0,076	0,057	0,060	0,049	0,056	0,055	0,059	0,062	0,054	0,060	0,065
14	0,012	0,018	0,019	0,023	0,027	0,030	0,034	0,037	0,045	0,046	0,045
15	0,051	0,048	0,035	0,037	0,036	0,036	0,040	0,046	0,052	0,058	0,069
16	0,010	0,012	0,015	0,018	0,021	0,023	0,026	0,029	0,034	0,037	0,043
17	0,041	0,048	0,036	0,037	0,031	0,035	0,040	0,048	0,054	0,058	0,063
18	0,009	0,011	0,012	0,015	0,018	0,021	0,021	0,024	0,029	0,032	0,036
19	0,049	0,044	0,032	0,030	0,030	0,034	0,039	0,046	0,053	0,056	0,062
20	0,009	0,011	0,011	0,014	0,017	0,019	0,020	0,021	0,026	0,028	0,031
21	0,056	0,046	0,051	0,033	0,036	0,040	0,044	0,049	0,057	0,060	0,064
22	0,009	0,010	0,023	0,019	0,028	0,018	0,024	0,018	0,022	0,025	0,027
23	0,045	0,041	0,047	0,031	0,036	0,048	0,046	0,046	0,051	0,053	0,057
24	0,009	0,010	0,010	0,018	0,023	0,030	0,117	0,018	0,020	0,022	0,024
25	0,045	0,041	0,030	0,028	0,030	0,043	0,074	0,054	0,051	0,054	0,058
26	0,009	0,009	0,009	0,010	0,012	0,022	0,110	0,020	0,017	0,019	0,022
27	0,051	0,044	0,033	0,031	0,033	0,037	0,043	0,049	0,054	0,054	0,055
28	0,009	0,009	0,009	0,011	0,011	0,013	0,018	0,014	0,016	0,018	0,019
29	0,048	0,042	0,030	0,028	0,030	0,034	0,039	0,042	0,050	0,050	0,053
30	0,009	0,009	0,009	0,009	0,010	0,012	0,012	0,013	0,014	0,016	0,018
31	0,041	0,038	0,028	0,026	0,029	0,033	0,036	0,040	0,046	0,046	0,047
32	0,009	0,009	0,009	0,010	0,010	0,011	0,012	0,012	0,013	0,015	0,016
33	0,041	0,037	0,028	0,026	0,028	0,032	0,036	0,040	0,047	0,046	0,047
34	0,008	0,009	0,008	0,009	0,010	0,011	0,012	0,012	0,013	0,014	0,015
35	0,040	0,033	0,026	0,024	0,026	0,031	0,035	0,036	0,040	0,039	0,039
36	0,009	0,009	0,008	0,008	0,009	0,010	0,011	0,012	0,012	0,013	0,014
37	0,038	0,034	0,026	0,024	0,025	0,030	0,034	0,034	0,044	0,042	0,042
38	0,008	0,008	0,008	0,008	0,009	0,010	0,011	0,011	0,011	0,012	0,013
39	0,035	0,033	0,026	0,025	0,028	0,033	0,037	0,039	0,044	0,040	0,042
40	0,008	0,008	0,008	0,009	0,009	0,010	0,010	0,011	0,011	0,012	0,013

Interharmonics											
P/P _n [%]	0	10	20	30	40	50	60	70	80	90	100
f [Hz]	I [%]	I [%]	I [%]	I [%]	I [%]	I [%]	I [%]	I [%]	I [%]	I [%]	I [%]
75	0,038	0,070	0,092	0,096	0,123	0,151	0,175	0,185	0,175	0,214	0,218
125	0,042	0,051	0,059	0,070	0,100	0,118	0,137	0,143	0,136	0,170	0,178
175	0,061	0,105	0,092	0,070	0,084	0,099	0,114	0,123	0,139	0,172	0,197
225	0,049	0,061	0,051	0,059	0,077	0,101	0,099	0,096	0,094	0,112	0,120
275	0,263	0,253	0,396	0,412	0,422	0,431	0,420	0,415	0,216	0,151	0,111
325	0,080	0,095	0,035	0,044	0,057	0,084	0,074	0,074	0,122	0,114	0,149
375	0,472	0,778	0,778	0,791	0,842	0,908	1,036	1,199	1,578	1,884	2,362
425	0,083	0,078	0,088	0,080	0,084	0,071	0,107	0,124	0,068	0,162	0,156
475	0,266	0,561	0,692	0,755	0,825	0,910	1,025	1,184	1,610	1,886	2,382
525	0,053	0,054	0,031	0,037	0,047	0,068	0,057	0,061	0,124	0,112	0,157
575	0,279	0,304	0,375	0,388	0,400	0,404	0,405	0,402	0,164	0,137	0,090
625	0,050	0,047	0,033	0,040	0,044	0,045	0,050	0,052	0,051	0,058	0,060
675	0,092	0,061	0,085	0,056	0,047	0,049	0,067	0,097	0,108	0,151	0,197
725	0,036	0,030	0,023	0,027	0,029	0,031	0,032	0,035	0,035	0,043	0,056
775	0,043	0,036	0,059	0,053	0,045	0,042	0,043	0,044	0,040	0,043	0,045
825	0,027	0,024	0,022	0,024	0,025	0,028	0,027	0,028	0,032	0,035	0,042
875	0,024	0,027	0,034	0,040	0,036	0,032	0,033	0,034	0,030	0,036	0,038
925	0,023	0,022	0,021	0,022	0,027	0,026	0,026	0,026	0,028	0,031	0,034
975	0,018	0,022	0,028	0,031	0,032	0,037	0,029	0,030	0,029	0,030	0,036
1025	0,019	0,023	0,026	0,022	0,085	0,029	0,028	0,025	0,026	0,028	0,032
1075	0,018	0,022	0,029	0,056	0,065	0,041	0,031	0,037	0,025	0,027	0,030
1125	0,017	0,022	0,023	0,046	0,088	0,090	0,056	0,036	0,024	0,027	0,029
1175	0,018	0,018	0,019	0,050	0,025	0,079	0,056	0,174	0,024	0,026	0,028
1225	0,016	0,017	0,017	0,019	0,022	0,082	0,055	0,155	0,022	0,025	0,026
1275	0,017	0,018	0,017	0,018	0,020	0,025	0,032	0,162	0,021	0,024	0,026
1325	0,017	0,017	0,018	0,017	0,019	0,021	0,021	0,037	0,020	0,023	0,024
1375	0,016	0,016	0,017	0,017	0,019	0,020	0,020	0,032	0,020	0,023	0,024
1425	0,016	0,016	0,016	0,017	0,017	0,018	0,018	0,019	0,019	0,021	0,023
1475	0,015	0,016	0,016	0,016	0,017	0,018	0,019	0,021	0,019	0,021	0,023
1525	0,016	0,016	0,016	0,016	0,017	0,018	0,018	0,020	0,019	0,020	0,022
1575	0,015	0,015	0,015	0,016	0,017	0,017	0,018	0,019	0,018	0,020	0,022
1625	0,015	0,015	0,015	0,015	0,017	0,018	0,018	0,018	0,018	0,019	0,021
1675	0,015	0,015	0,015	0,015	0,016	0,017	0,018	0,019	0,018	0,020	0,021
1725	0,015	0,015	0,015	0,015	0,016	0,017	0,018	0,019	0,017	0,019	0,020
1775	0,014	0,015	0,014	0,014	0,015	0,016	0,017	0,018	0,018	0,019	0,020
1825	0,015	0,015	0,014	0,015	0,016	0,017	0,018	0,018	0,017	0,018	0,019
1875	0,015	0,015	0,014	0,015	0,015	0,016	0,017	0,018	0,017	0,019	0,020
1925	0,015	0,015	0,014	0,015	0,016	0,017	0,017	0,017	0,016	0,017	0,019
1975	0,015	0,015	0,014	0,015	0,015	0,016	0,017	0,018	0,017	0,018	0,020

Higher Frequencies											
P/P _n [%]	0	10	20	30	40	50	60	70	80	90	100
f [kHz]	I [%]	I [%]	I [%]	I [%]	I [%]	I [%]	I [%]	I [%]	I [%]	I [%]	I [%]
2,1	0,057	0,053	0,046	0,047	0,049	0,055	0,058	0,062	0,063	0,065	0,065
2,3	0,058	0,054	0,051	0,051	0,052	0,057	0,061	0,064	0,068	0,065	0,066
2,5	0,065	0,063	0,056	0,056	0,056	0,061	0,066	0,069	0,070	0,067	0,069
2,7	0,053	0,051	0,045	0,047	0,050	0,055	0,057	0,060	0,061	0,061	0,058
2,9	0,046	0,045	0,044	0,047	0,050	0,054	0,055	0,055	0,059	0,058	0,059
3,1	0,048	0,051	0,051	0,058	0,061	0,062	0,061	0,061	0,061	0,059	0,060
3,3	0,067	0,081	0,080	0,083	0,075	0,070	0,065	0,061	0,064	0,064	0,068
3,5	0,064	0,098	0,144	0,111	0,087	0,074	0,066	0,062	0,061	0,061	0,062
3,7	0,200	0,468	0,412	0,373	0,352	0,343	0,337	0,335	0,348	0,353	0,353
3,9	0,219	0,412	0,327	0,319	0,320	0,324	0,325	0,327	0,359	0,362	0,366
4,1	0,094	0,116	0,112	0,092	0,081	0,077	0,075	0,074	0,066	0,066	0,067
4,3	0,074	0,078	0,082	0,078	0,078	0,077	0,076	0,075	0,063	0,062	0,063
4,5	0,050	0,055	0,058	0,059	0,060	0,062	0,061	0,062	0,054	0,053	0,053
4,7	0,079	0,084	0,087	0,088	0,088	0,088	0,088	0,088	0,072	0,071	0,070
4,9	0,039	0,042	0,040	0,040	0,040	0,039	0,039	0,039	0,037	0,038	0,038
5,1	0,041	0,040	0,037	0,037	0,037	0,037	0,037	0,037	0,034	0,035	0,035
5,3	0,033	0,034	0,033	0,033	0,032	0,032	0,033	0,032	0,031	0,032	0,033
5,5	0,033	0,033	0,031	0,030	0,031	0,031	0,031	0,031	0,029	0,031	0,030
5,7	0,033	0,032	0,033	0,031	0,031	0,031	0,032	0,032	0,030	0,030	0,032
5,9	0,031	0,030	0,031	0,031	0,031	0,032	0,033	0,032	0,030	0,029	0,031
6,1	0,034	0,034	0,033	0,034	0,033	0,034	0,034	0,034	0,031	0,031	0,031
6,3	0,038	0,042	0,038	0,034	0,035	0,033	0,034	0,033	0,030	0,031	0,029
6,5	0,041	0,037	0,037	0,039	0,039	0,041	0,043	0,037	0,031	0,037	0,032
6,7	0,035	0,034	0,030	0,033	0,031	0,034	0,032	0,039	0,036	0,034	0,039
6,9	0,031	0,040	0,033	0,031	0,031	0,031	0,031	0,031	0,033	0,030	0,036
7,1	0,044	0,049	0,041	0,038	0,037	0,038	0,038	0,038	0,034	0,036	0,046
7,3	0,034	0,039	0,037	0,036	0,034	0,034	0,034	0,034	0,030	0,032	0,036
7,5	0,031	0,032	0,033	0,034	0,033	0,033	0,033	0,033	0,030	0,031	0,031
7,7	0,031	0,031	0,033	0,032	0,034	0,033	0,033	0,032	0,030	0,031	0,031
7,9	0,031	0,031	0,032	0,032	0,031	0,034	0,033	0,033	0,030	0,031	0,032
8,1	0,031	0,032	0,031	0,032	0,031	0,032	0,034	0,035	0,031	0,032	0,033
8,3	0,034	0,035	0,035	0,037	0,035	0,034	0,035	0,037	0,032	0,034	0,035
8,5	0,033	0,034	0,033	0,035	0,034	0,034	0,035	0,036	0,032	0,033	0,033
8,7	0,031	0,031	0,032	0,031	0,036	0,036	0,034	0,034	0,030	0,031	0,032
8,9	0,031	0,031	0,031	0,030	0,030	0,035	0,039	0,039	0,030	0,031	0,031

Note:

The normalization current is 15,0A for HYD 3000-EP;
The normalization current is 27,3A for HYD 6000-EP;

The tests had been performed on the HYD 6000-EP and HYD 3000-EP are valid for the HYD 5500-EP, HYD 5000-EP, HYD 4600-EP, HYD 4000-EP and HYD 3680-EP, since it is identical in hardware and software construction except output power derated by software.

4.8 EMC and power quality Switching operation (Refer IEC 61400-21)		P			
Test result: HYD 6000-EP					
Max. number of switching operations, N_{10}	10				
Max. number of switching operations, N_{120}	120				
Case of switching operation		Cut-in at 9% $P_{E_{max}}$			
Grid impedance angle, ψ_k	30°	50°	70°	85°	
Flicker step factor, $k_f(\psi_k)$	0,056	0,036	0,030	0,028	
Voltage change factor, $k_u(\psi_k)$	0,334	0,338	0,349	0,347	
Maximum inrush current factor $k_{i_{max}}$	0,014				
Case of switching operation		Cut-in at 100% $P_{E_{max}}$			
Grid impedance angle, ψ_k	30°	50°	70°	85°	
Flicker step factor, $k_f(\psi_k)$	0,230	0,151	0,125	0,119	
Voltage change factor, $k_u(\psi_k)$	2,965	2,984	2,928	2,858	
Maximum inrush current factor $k_{i_{max}}$	0,014				
Case of switching operation		Service disconnection at rated power			
Grid impedance angle, ψ_k	30°	50°	70°	85°	
Flicker step factor, $k_f(\psi_k)$	0,093	0,061	0,051	0,045	
Voltage change factor, $k_u(\psi_k)$	2,424	2,507	2,592	2,441	
Maximum inrush current factor $k_{i_{max}}$	0,079				
Worst case over all switching operations, $k_{i_{max}}$	0,079				
Note:					
The tests had been performed on the HYD 6000-EP is valid for the HYD 5500-EP, HYD 5000-EP, HYD 4600-EP, HYD 4000-EP, HYD 3680-EP and HYD 3000-EP, since it is identical in hardware and software construction except output power derated by software.					
The test results refer to the test report "PVTR200917N016" issued by Bureau Veritas Shenzhen Co., Ltd. Dongguan Branch, dated on 2021.01.20.					

4.8	Voltage fluctuation and flicker	P
------------	--	----------

Test result:

Test conditions:	Maximum permissible voltage fluctuation (expressed as a percentage of nominal voltage at 100 % power) and flicker as per EN 61000-3-3 and/or EN 61000-3-11.
-------------------------	---

Test:

Value	P_{st}	P_{lt} 2 hours	d(t)_{500ms}	d_c	d_{max}
Limit	1,0	0,65	3,3%	3,3%	4%

Test value	See below
-------------------	-----------

inverter <16A (HYD 3000-EP)

	dc[%]	dmax[%]	d(t)[ms]	Pst	Plt
Limit	3.30	4.00	500 3.30%	1.00	0.65 N:12
No. 1	0.034 Pass	0.228 Pass	0.0 Pass	0.174 Pass	
2	0.034 Pass	0.219 Pass	0.0 Pass	0.174 Pass	
3	0.037 Pass	0.223 Pass	0.0 Pass	0.173 Pass	
4	0.036 Pass	0.223 Pass	0.0 Pass	0.173 Pass	
5	0.033 Pass	0.226 Pass	0.0 Pass	0.174 Pass	
6	0.036 Pass	0.226 Pass	0.0 Pass	0.174 Pass	
7	0.037 Pass	0.223 Pass	0.0 Pass	0.174 Pass	
8	0.038 Pass	0.221 Pass	0.0 Pass	0.174 Pass	
9	0.035 Pass	0.228 Pass	0.0 Pass	0.176 Pass	
10	0.041 Pass	0.233 Pass	0.0 Pass	0.176 Pass	
11	0.036 Pass	0.241 Pass	0.0 Pass	0.176 Pass	
12	0.037 Pass	0.235 Pass	0.0 Pass	0.176 Pass	
Result	Pass	Pass	Pass	Pass	0.175 Pass

Inverter >16A (HYD 6000-EP)

	dc[%]	dmax[%]	d(t)[ms]	Pst	Plt
Limit	3.30	4.00	500 3.30%	1.00	0.65 N:12
No. 1	0.046 Pass	0.217 Pass	0.0 Pass	0.164 Pass	
2	0.044 Pass	0.218 Pass	0.0 Pass	0.164 Pass	
3	0.044 Pass	0.227 Pass	0.0 Pass	0.164 Pass	
4	0.052 Pass	0.229 Pass	0.0 Pass	0.165 Pass	
5	0.051 Pass	0.224 Pass	0.0 Pass	0.166 Pass	
6	0.053 Pass	0.231 Pass	0.0 Pass	0.166 Pass	
7	0.040 Pass	0.226 Pass	0.0 Pass	0.165 Pass	
8	0.036 Pass	0.225 Pass	0.0 Pass	0.166 Pass	
9	0.046 Pass	0.233 Pass	0.0 Pass	0.166 Pass	
10	0.051 Pass	0.225 Pass	0.0 Pass	0.167 Pass	
11	0.047 Pass	0.229 Pass	0.0 Pass	0.168 Pass	
12	0.034 Pass	0.233 Pass	0.0 Pass	0.167 Pass	
Result	Pass	Pass	Pass	Pass	0.166 Pass

Note:

*The stationary deviance of dc% is more relevant than the dynamic deviance of dmax at starting and stopping, Mains Impedance according EN61000-3-11:

$R_{max} = 0,24\Omega$; $jX_{max} = 0,15\Omega @50Hz$ ($|Z_{max}| = 0,283/0,4717\Omega$) for single phase inverter use also

$R_n = 0,16\Omega$; $jX_n = 0,1\Omega$.

Calculation of the maximum permissible grid impedance at the point of common coupling based on dc:

$Z_{max} = Z_{ref} * 3,3\% / d_c(P_n)$.

The tests should be based on the limits of the EN 61000-3-3 for less than 16A and on EN 61000-3-11 for more than 16A.

The tests had been performed on the HYD 6000-EP and HYD 3000-EPs valid for the HYD 5500-EP, HYD 5000-EP, HYD 4600-EP, HYD 4000-EP and HYD 3680-EP, since it is identical in hardware and software construction except output power derated by software.

The test results refer to the test report "PVTR200917N016" issued by Bureau Veritas Shenzhen Co., Ltd. Dongguan Branch, dated on 2021.01.20.

4.8 EMC and power quality Flicker and voltage fluctuations				P
Method: Measurement and evaluation was carried out according to the procedure in IEC 61400-21.				
Test result:				
HYD 3000-EP				
Grid impedance angle, ψ_k	30°	50°	70°	85°
Flicker coefficient, $c(\psi_k)$	6,339	4,138	3,373	3,182
Short-term flicker, P_{st}	0,187	0,122	0,099	0,094
HYD 6000-EP				
Grid impedance angle, ψ_k	30°	50°	70°	85°
Flicker coefficient, $c(\psi_k)$	4,440	2,898	2,363	2,229
Short-term flicker, P_{st}	0,178	0,116	0,095	0,089
Note:				
The table entries are worst case values.				
The tests had been performed on the HYD 6000-EP and HYD 3000-EP is valid for the HYD 5500-EP, HYD 5000-EP, HYD 4600-EP, HYD 4000-EP and HYD 3680-EP, since it is identical in hardware and software construction except output power derated by software.				
The test results refer to the test report "PVTR200917N016" issued by Bureau Veritas Shenzhen Co., Ltd. Dongguan Branch, dated on 2021.01.20.				

4.8 EMC and power quality DC-Injection					P
Test result: HYD 3000-EP					
Protection limit	Tested at four power levels limit 0,5% of $I_{AC;nom}$ (65mA)				
Output power	~20%	~50%	75%	~100%	
Abs. Max. Test Value:L1 [mA]	25,1	24,0	23,5	15,3	
Abs. Ave. Test Value:L1 [mA]	14,0	12,8	10,7	0,6	
Test result: HYD 6000-EP					
Protection limit	Tested at four power levels limit 0,5% of $I_{AC;nom}$ (145mA)				
Output power	~20%	~50%	75%	~100%	
Abs. Max. Test Value:L1 [mA]	23,8	22,5	23,5	36,8	
Abs. Ave. Test Value:L1 [mA]	12,6	11,0	9,6	5,1	
<p>Note: Test method and setting value refer Annex D.3.10 of EN 50438:2013. The tests had been performed on the HYD 6000-EP and HYD 3000-EPs valid for the HYD 5500-EP, HYD 5000-EP, HYD 4600-EP, HYD 4000-EP and HYD 3680-EP, since it is identical in hardware and software construction except output power derated by software. The test results refer to the test report "PVTR200917N016" issued by Bureau Veritas Shenzhen Co., Ltd. Dongguan Branch, dated on 2021.01.20.</p>					

Diagram of permanent dc-injection of HYD 3000-EP

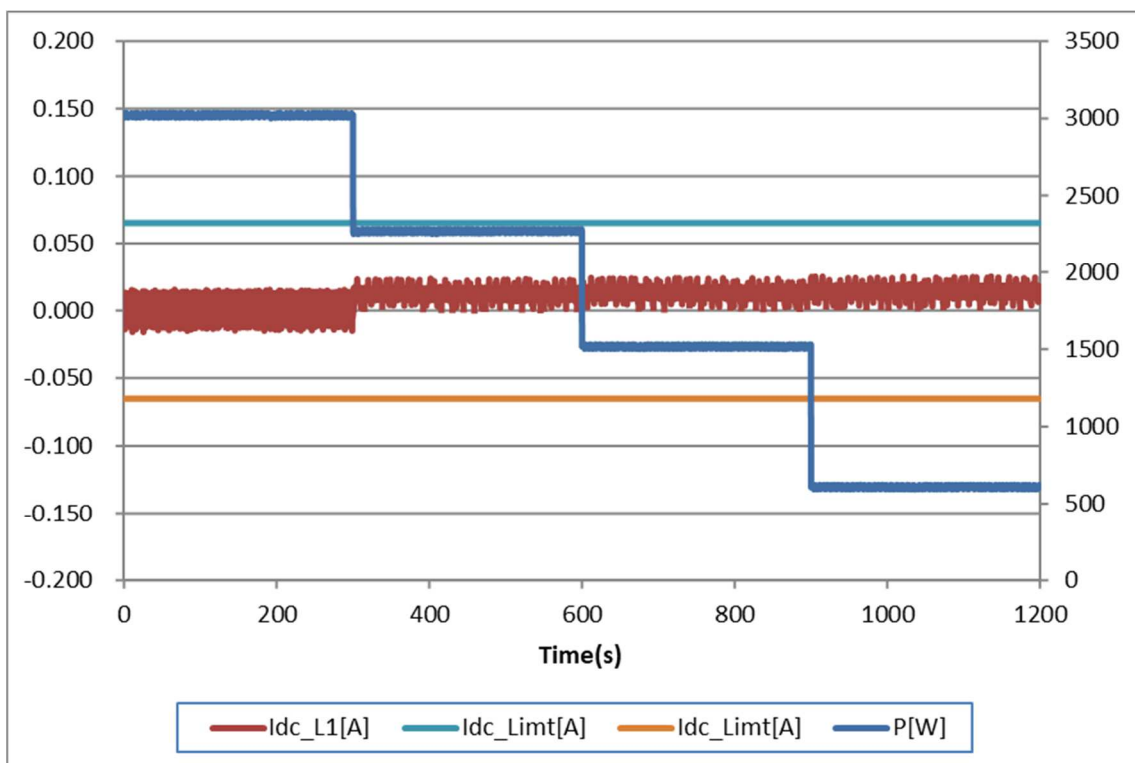
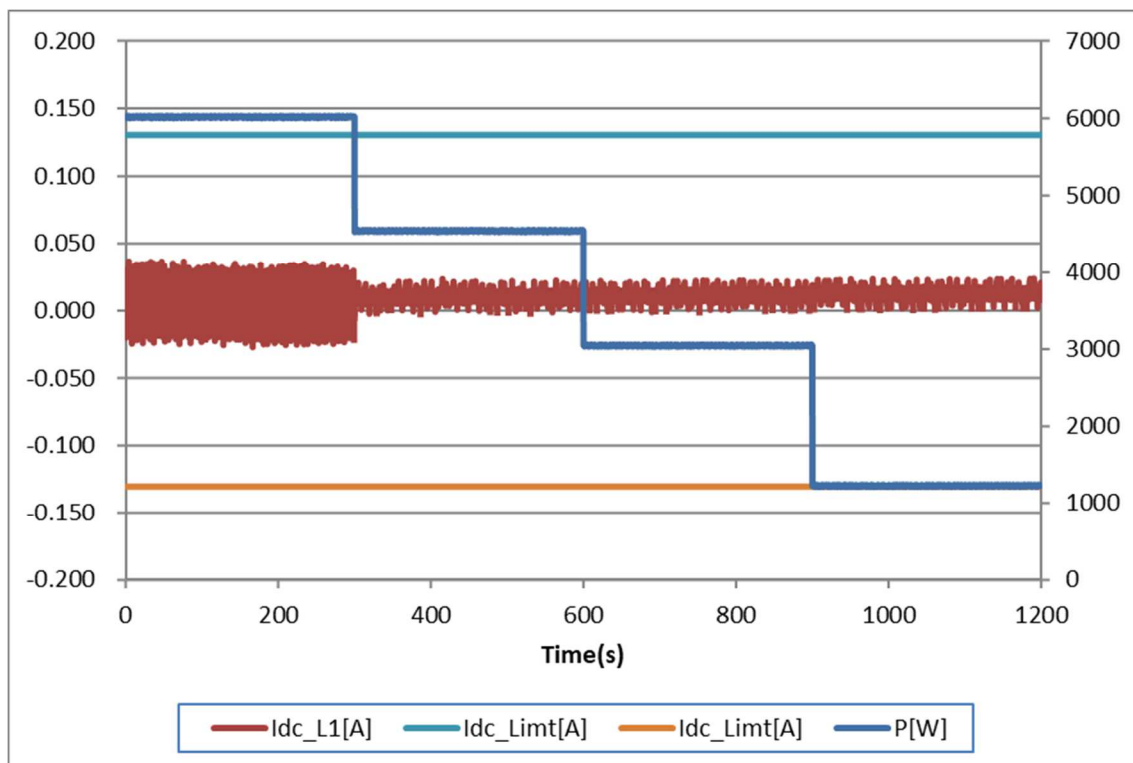
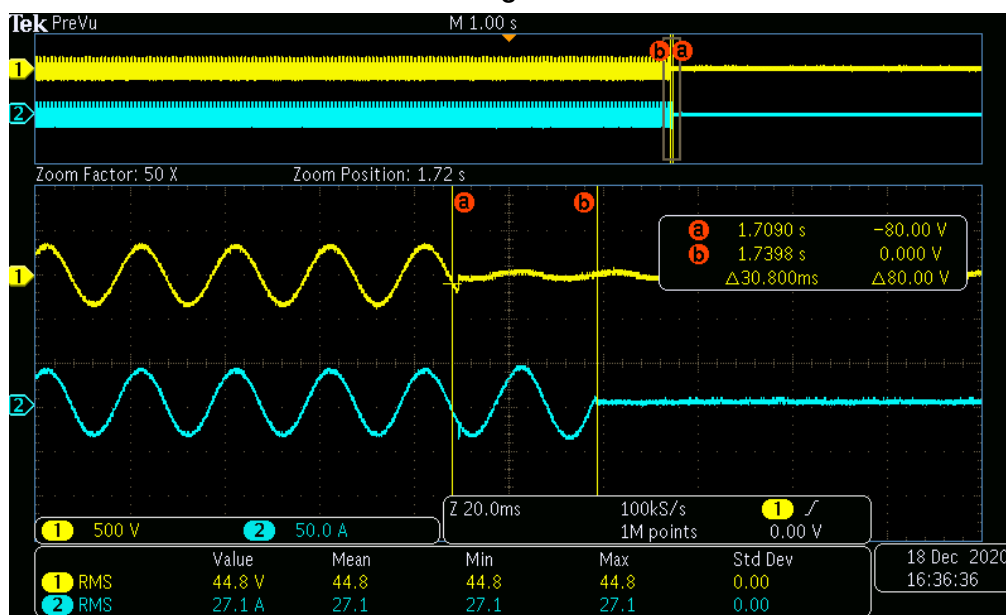

Diagram of permanent dc-injection of HYD 6000-EP



4.8 Immunity to voltage dips and short interruptions			P		
For a directly coupled SSEG			For a Inverter SSEG		
Parameter	Symbol	Value	Time after fault	Volts	Amps
Peak Short Circuit current	I_p	N/A	20ms	80	27,5
Initial Value of aperiodic current	A	N/A	100ms	N/A	N/A
Initial symmetrical short-circuit current*	I_k	N/A	250ms	N/A	N/A
Decaying (aperiodic) component of short circuit current*	i_{DC}	N/A	500ms	N/A	N/A
Reactance/Resistance Ratio of source*	X/R	N/A	Time to trip	30,8ms	In seconds

Diagram



Note:

For rotating machines and linear piston machines the test should produce a 0s – 2s plot of the short circuit current as seen at the Generating Unit terminals.

* Values for these parameters should be provided where the short circuit duration is sufficiently long to enable interpolation of the plot.

The tests had been performed on the HYD 6000-EP is valid for the HYD 5500-EP, HYD 5000-EP, HYD 4600-EP, HYD 4000-EP, HYD 3680-EP and HYD 3000-EP, since it is identical in hardware and software construction except output power derated by software.

The test results refer to the test report "PVTR200917N016" issued by Bureau Veritas Shenzhen Co., Ltd. Dongguan Branch, dated on 2021.01.20.

EN 50549-1:2019: Interface protection

Clause	Test requirement	Test procedure according standard	Result
4.9.3	Requirements on voltage and frequency protection	CEI 0-21:2019-04, Annex A.3.1 to A.3.4	P
4.9.3.1	Undervoltage protection	EN 50438, Annex D.2.3	P
	Overvoltage protection	EN 50438, Annex D.2.3	P
	Overvoltage 10 min mean protection	EN 50160	P
	Underfrequency protection	EN 50438, Annex D.2.4	P
	Overfrequency protection	EN 50438, Annex D.2.4	P
4.9.4.2	Loss of Mains (LoM) detection	IEC 62116:2014	P

4.9.3 Requirements on voltage and frequency protection Checklist						P
Several points to check						
Clause 4.9.3.1 to 4.9.3.6	All thresholds must be adjustable					P
Voltage values						
Threshold	Stage 1 [27 <]			Stage 2 [27 <<]		
	Operate voltage	Operate time	Operate voltage	Operate time	Operate voltage	Operate time
Range	0,2-1,0 U _n	0,1-100s	0,2-1,0 U _n	0,1-5s	0,2-1,0 U _n	0,1-5s
Steps	0,01 U _n	0,1 s	0,01 U _n	0,05s	0,01 U _n	0,05s
Threshold	Stage 1 [59 >]		Stage 2 [59 >>]		Overvoltage 10 min mean protection	
	Operate voltage	Operate time	Operate voltage	Operate time	Operate voltage	Operate time
Range	1,0-1,2 U _n	0,1-100s	1,0-1,3 U _n	0,1-5s	1,0-1,15 U _n	3s not adjustable
Steps	0,01 U _n	0,1s	0,01 U _n	0,05s	0,01 U _n	--
Frequency values						
Threshold	Stage 1 [81 <]			Stage 2 [81 <<]		
	Operate frequency	Operate time	Operate frequency	Operate time	Operate frequency	Operate time
Range	47,0-50,0Hz	0,1-100s	47,0-50,0Hz	0,1-5s	47,0-50,0Hz	0,1-5s
Steps	0,1 Hz	0,1 s	0,1 Hz	0,05s	0,1 Hz	0,05s
Threshold	Stage 1 [81 >]			Stage 2 [81 >>]		
	Operate frequency	Operate time	Operate frequency	Operate time	Operate frequency	Operate time
Range	50,0-52,0Hz	0,1-100s	50,0-52,0Hz	0,1-5s	50,0-52,0Hz	0,1-5s
Steps	0,1 Hz	0,1 s	0,1 Hz	0,05s	0,1 Hz	0,05s
4.9.2.6	Insensitive against 40ms frequency transients, so that the unit will not trip					P
Note:						
The tests had been performed on the HYD 20KTL-3PH is valid for the HYD 15KTL-3PH, HYD 10KTL-3PH, HYD 8KTL-3PH, HYD 6KTL-3PH and HYD 5KTL-3PH since it is similar in hardware and just power derated by software.						
The test results refer to the test report "PVTR200917N016" issued by Bureau Veritas Shenzhen Co., Ltd. Dongguan Branch, dated on 2021.01.20.						

4.9.3 Requirements on voltage and frequency protection					P
4.9.3.1 General (Interface protection: Over/under voltage) (Setting value refer EN 50438 for default settings)					
Test conditions			Frequency: 50+/-0,2Hz		
Phase	Limit [V]	Trip value [V]	Voltage step [V]	Disconnection time [s]	Limit [s]
L1	110% of U_n = 253,0 (stage 1)*	253,9	230,0 to 258,0	2,544	3,0
		253,9	230,0 to 258,0	2,534	
		253,7	230,0 to 258,0	2,536	
		253,9	230,0 to 258,0	2,542	
		253,8	230,0 to 258,0	2,538	
	115% of U_n = 264,5 (stage 2)	264,9	230,0 to 268,0	0,139	0,1 ≤ t ≤ 0,2
		264,9	230,0 to 268,0	0,128	
		264,9	230,0 to 268,0	0,137	
		264,8	230,0 to 268,0	0,132	
		264,9	230,0 to 268,0	0,133	
	85% of U_n = 195,5	196,0	230,0 to 192,0	1,235	1,2 ≤ t ≤ 1,5
		196,0	230,0 to 192,0	1,250	
		196,0	230,0 to 192,0	1,246	
		196,0	230,0 to 192,0	1,240	
		196,0	230,0 to 192,0	1,244	

Note:

*Over-voltage - stage 1: 10-min-value corresponding to EN 50160.
The calculation of the 10 min value shall comply with the 10 min aggregation of EN 61000-4-30, class S. The function shall be based on the calculation of the square root of the arithmetic mean of the squared input values over 10 min. In deviation from EN 61000-4-30, a moving window shall be used. The calculation of a new 10-min value at least every 3 s is sufficient, which is then to be compared with the trip value.
Tolerances on disconnection time are ± 10 % .

The trip values were evaluated by varying the applied voltage from U_n down to U_{th-low} - 2% of U_n in steps of 0,5% of U_n for under-voltage testing as well as from U_n up to $U_{th-high}$ + 2% of U_n in steps of 0.5% of U_n for over-voltage testing. Lower and upper threshold voltage shall not fall or rise below or above 2,3V of the trip value itself. The disconnection time was measured by application of a negative voltage step from U_n to the operate value - 5% of U_n as well as positive voltage step from U_n to the operate value + 5% of U_n .

The tests had been performed on the HYD 6000-EP is valid for the HYD 5500-EP, HYD 5000-EP, HYD 4600-EP , HYD 4000-EP, HYD 3680-EP and HYD 3000-EP, since it is identical in hardware and software construction except output power derated by software.

The test results refer to the test report "PVTR200917N016" issued by Bureau Veritas Shenzhen Co., Ltd. Dongguan Branch, dated on 2021.01.20.

Scope pictures of the disconnection time

Over-voltage - Stage 1 (L1 phase)

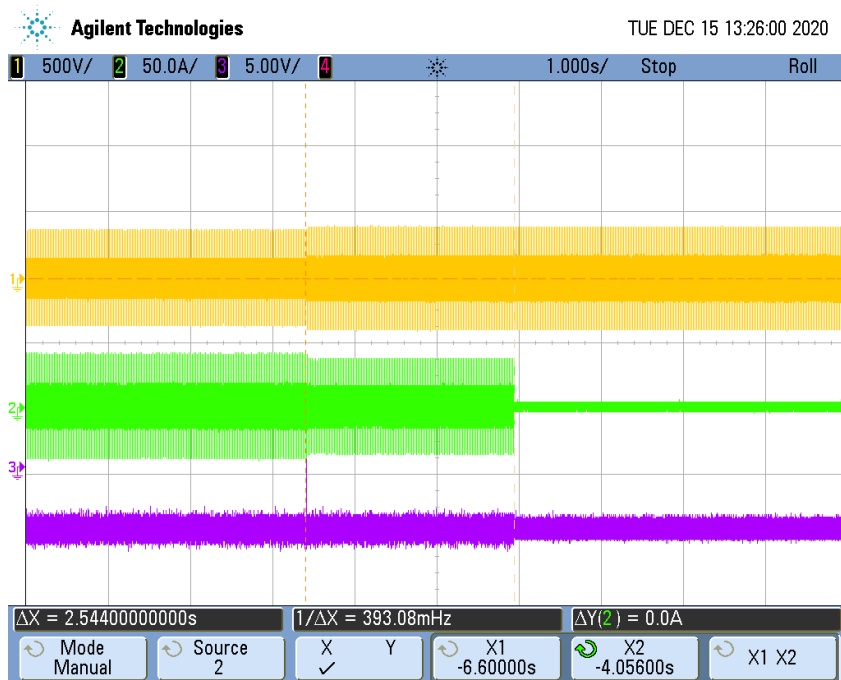

Over-voltage - Stage 2 (L1 phase)

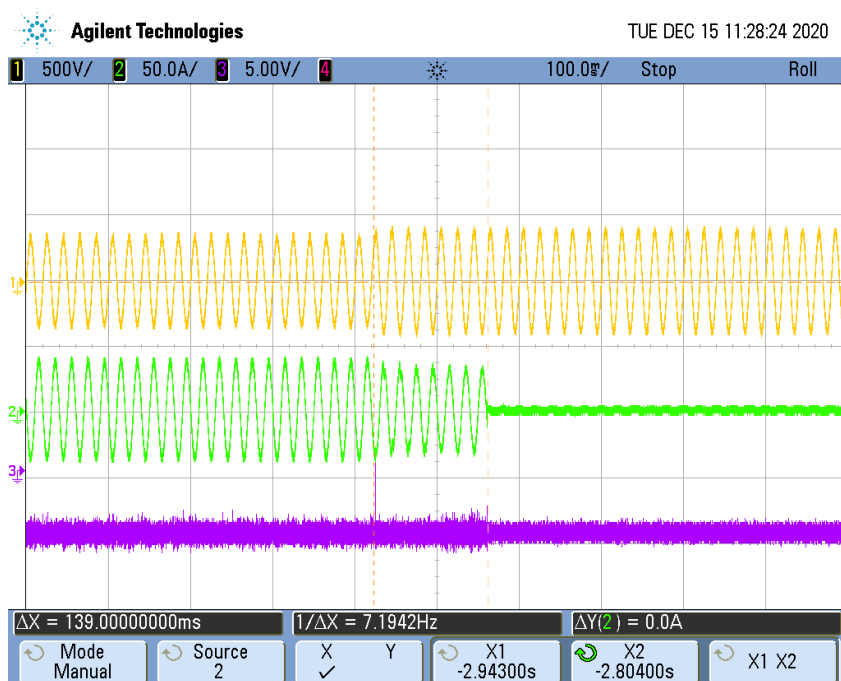

Under-voltage - Stage 1 (L1 phase)

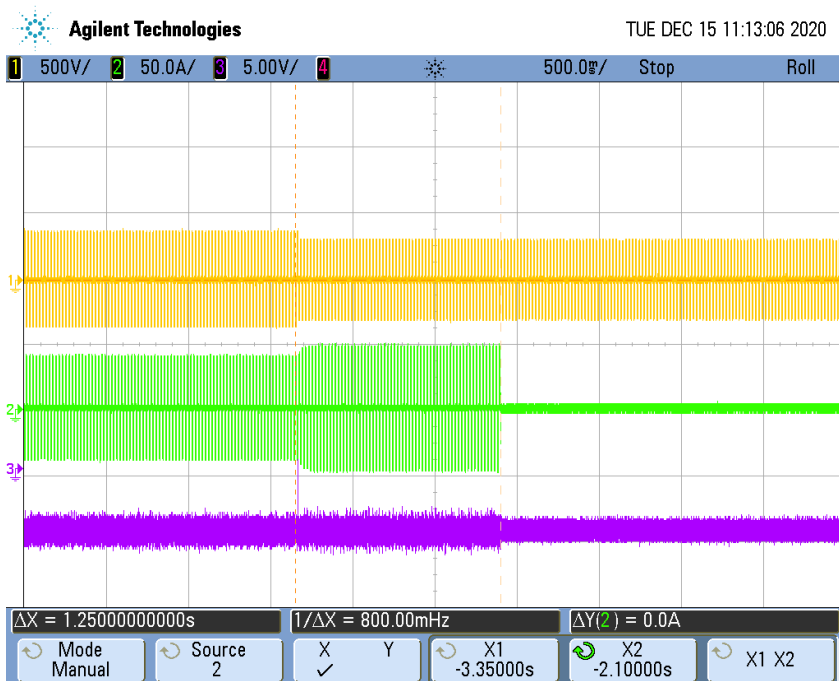

4.9.3 Requirements on voltage and frequency protection		P
4.9.3.1 General (Maximum voltage 10 min mean protection according to EN 50160) (Setting value refer EN 50438 for default settings)		
Setting values of the protection:	Trip value Setting [V]	253
	Setting $T_{\text{disconnection trip value}}$ [s]	600
	Setting $T_{\text{disconnection}}$ [ms]	200
Test:		
	Disconnection time [s]	Limit [s]
a)	The voltage is set to 100% U_n and held for 600 s, Thereafter the voltage is set to 112% U_n , Disconnection must take place within 600 s,	
	Phase 1:	488 s
	Phase 2:	--
	Phase 3:	--
b)	The voltage is set to U_n for 600 s and then to 108% U_n for 600 s, No disconnection should take place,	
	Phase 1:	No Disconnection
	Phase 2:	--
	Phase 3:	--
c)	The voltage is set to 106 % U_n and held for 600 s, Thereafter the voltage is set to 114 % U_n , The disconnection should last for half the period as in Point a)*	
	Phase 1:	301 s
	Phase 2:	--
	Phase 3:	--
<p>Test:</p> <p>a) This test serves as proof of the measurement accuracy and the maximum set time.</p> <p>b) This test serves as proof of the measurement accuracy.</p> <p>c) This test serves as proof of the correct formation of the 1 minute running mean value.</p>		
<p>Assessment criterion:</p> <p>The permitted tolerance between setting value and trip value of the voltage may not exceed $\pm 1\%$ of U_N.</p> <p><u>Limit values:</u></p> <p>Rise-in voltage protection 1,1 U_N after a max. 600 s, the switch off after 200 ms.</p>		
<p>Note:</p> <p>If only one integrated protection is used for the power generation systems, the value of the rise-in voltage protection of 1,1 U_N may not be changed.</p> <p>*If the setting value is set to 600 s, then the disconnection time can be in the range between 225 s and 375 s.</p> <p>The tests had been performed on the HYD 6000-EP is valid for the HYD 5500-EP, HYD 5000-EP, HYD 4600-EP , HYD 4000-EP, HYD 3680-EP and HYD 3000-EP, since it is identical in hardware and software construction except output power derated by software.</p> <p>The test results refer to the test report "PVTR200917N016" issued by Bureau Veritas Shenzhen Co., Ltd. Dongguan Branch, dated on 2021.01.20.</p>		

Graph of test a) Voltage set to 112 % U_n :

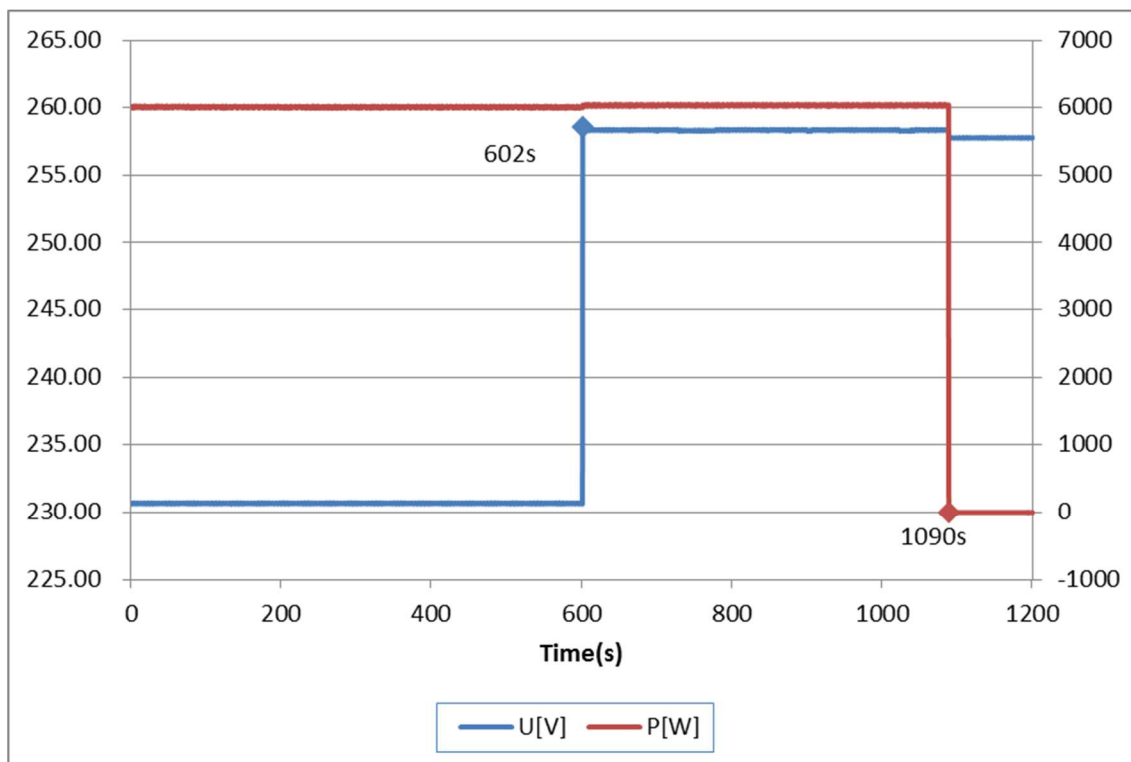

Graph of test b) Voltage set to 108 % U_n :

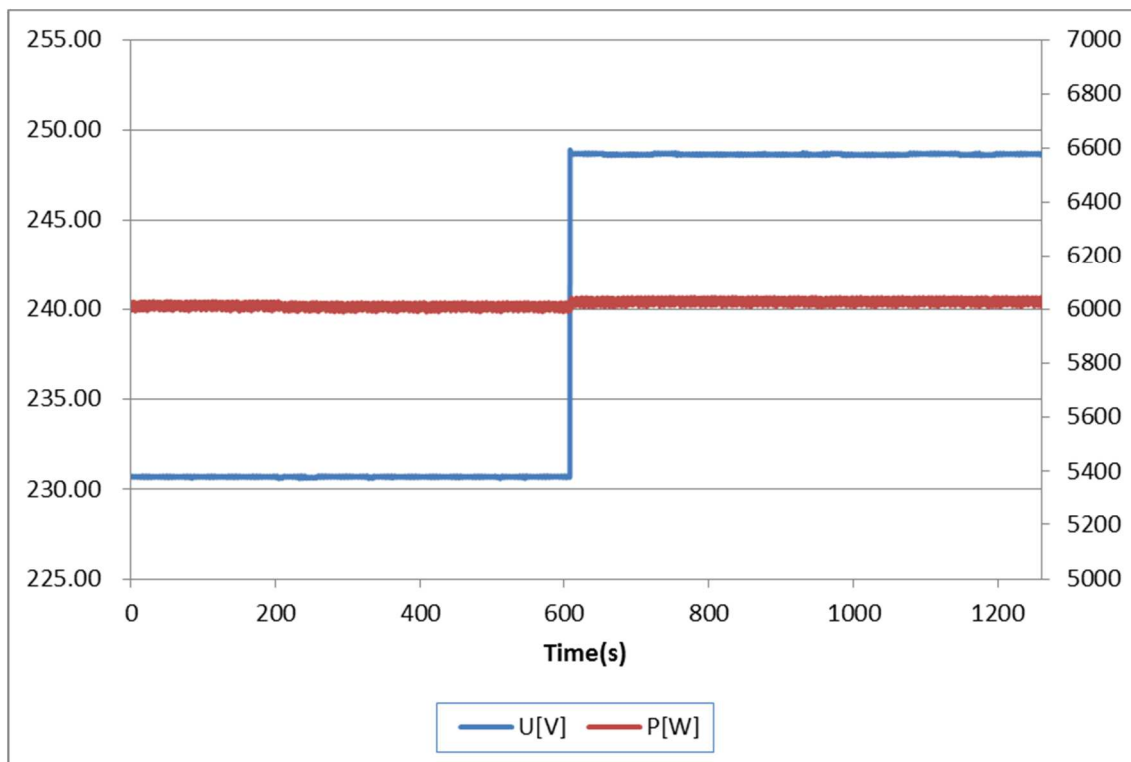

Graph of test c) Voltage set to 106 % U_n , thereafter 114% U_n :

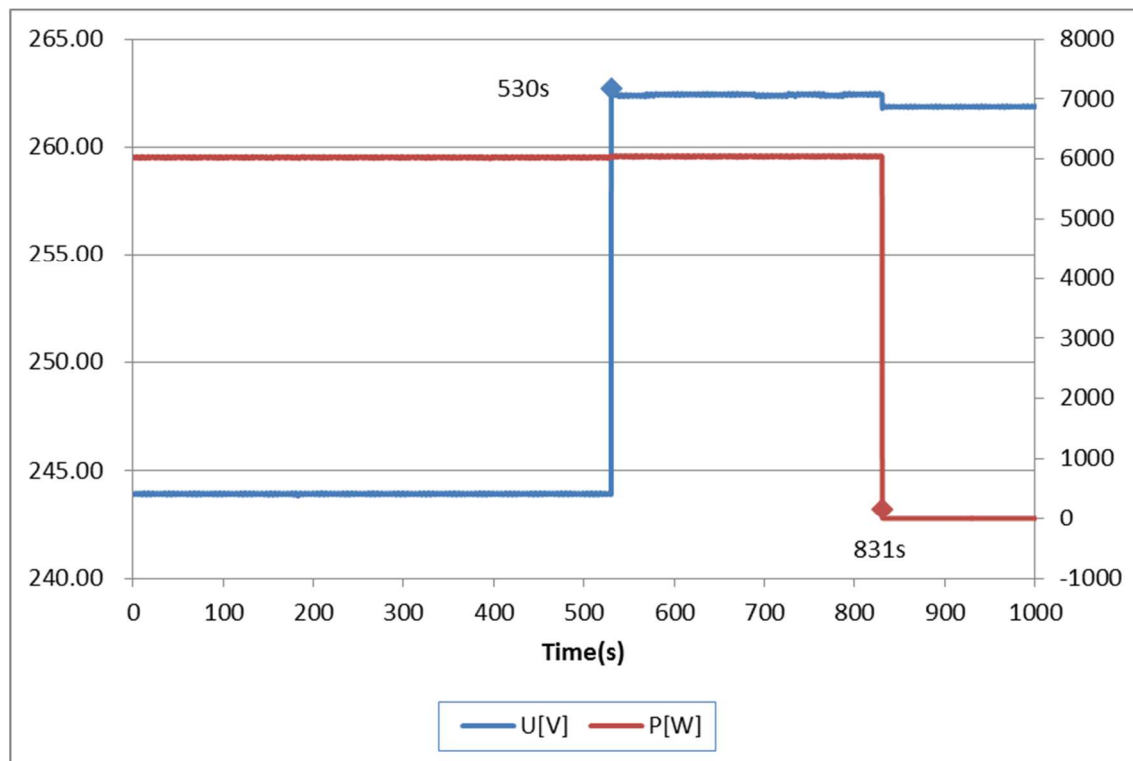

4.9.3 Requirements on voltage and frequency protection				P
4.9.3.1 General (Interface protection: Over/under frequency) (Setting value refer EN 50438 Default setting)				
Test conditions	U _n = 230Vac			
	Under-frequency		Over-frequency	
Parameter	Under-Frequency	Time	Over-Frequency	Time
Limit	47,50 Hz	0,3 ≤ t ≤ 0,5 s s	52,00 Hz	0,3 ≤ t ≤ 0,5 s
Trip value [Hz]	47,50		52,00	
	47,50		52,00	
	47,49		52,00	
	47,50		52,00	
	47,49		52,00	
Disconnection time [s]	48,00 Hz to 47,40 Hz	0,342	51,50 Hz to 52,10 Hz	0,364
		0,330		0,356
		0,326		0,354
		0,346		0,344
		0,336		0,370

Note:

For under-frequency testing the applied frequency is varied from f_n down to $f_{th-low} - 0,1$ Hz in steps of 0,025 Hz with a time duration per step exceeding the configured disconnection time, The operate value is the value of the applied frequency at switch the protection function trips and shall be within $f_{th-low} \pm 0,05$ Hz.

For over-frequency testing the applied frequency is varied from f_n up to $f_{th-high} + 0,1$ Hz in steps of 0,025 Hz with a time duration per step exceeding the configured disconnection time, The operate value is the value of the applied frequency at which the protection function trips and shall be within $f_{th-high} \pm 0,05$ Hz.

The oscilloscope pictures below show the measured worst case disconnection times.

The tests had been performed on the HYD 6000-EP is valid for the HYD 5500-EP, HYD 5000-EP, HYD 4600-EP, HYD 4000-EP, HYD 3680-EP and HYD 3000-EP, since it is identical in hardware and software construction except output power derated by software.

The test results refer to the test report "PVTR200917N016" issued by Bureau Veritas Shenzhen Co., Ltd. Dongguan Branch, dated on 2021.01.20.

Scope pictures of the disconnection time

Under-frequency



Over-frequency

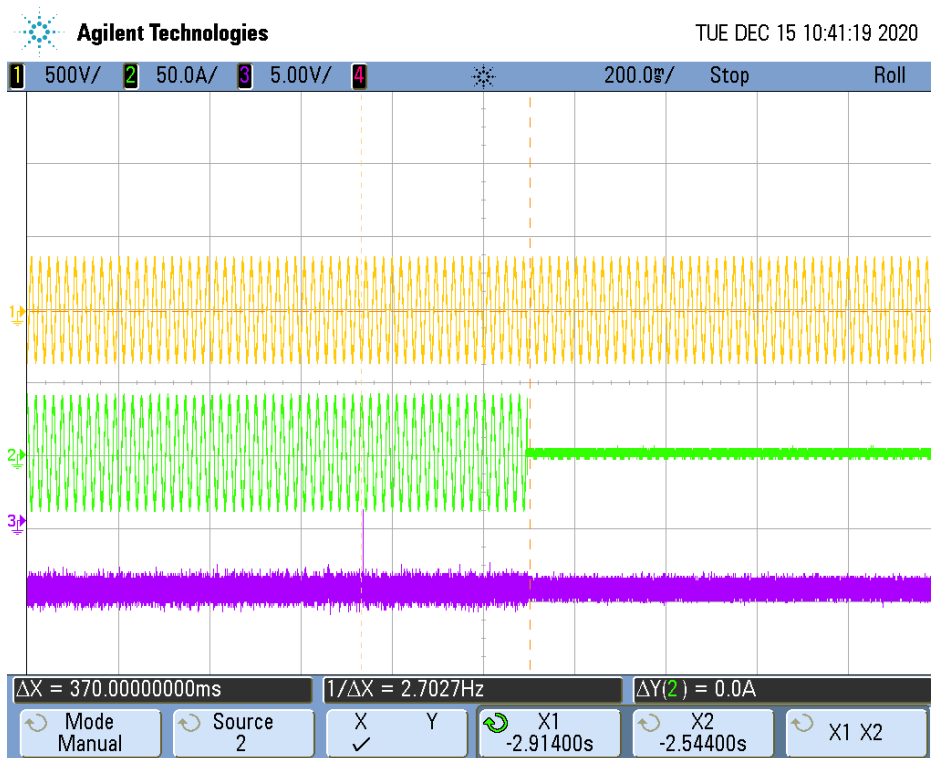

4.9.4.2 Loss of Mains (LoM) detection

Test circuit and parameters

Parameter	Symbol	Units
EUT DC Input		
DC voltage	V_{DC}	V
DC Current	I_{DC}	A
DC Power	P_{DC}	W
EUT AC output		
AC voltage	V_{EUT}	V
AC current	I_{EUT}	A
Real power	P_{EUT}	W
Reactive power	Q_{EUT}	VAr
Test Load		
Resistive load current	I_R	A
Inductive load current	I_L	A
Capacitive load current	I_C	A
AC (utility) power source		
Utility real power	P_{AC}	W
Utility reactive power	Q_{AC}	VAr
Utility current	I_{AC}	A

Block diagram test circuit IEC 62116:2014

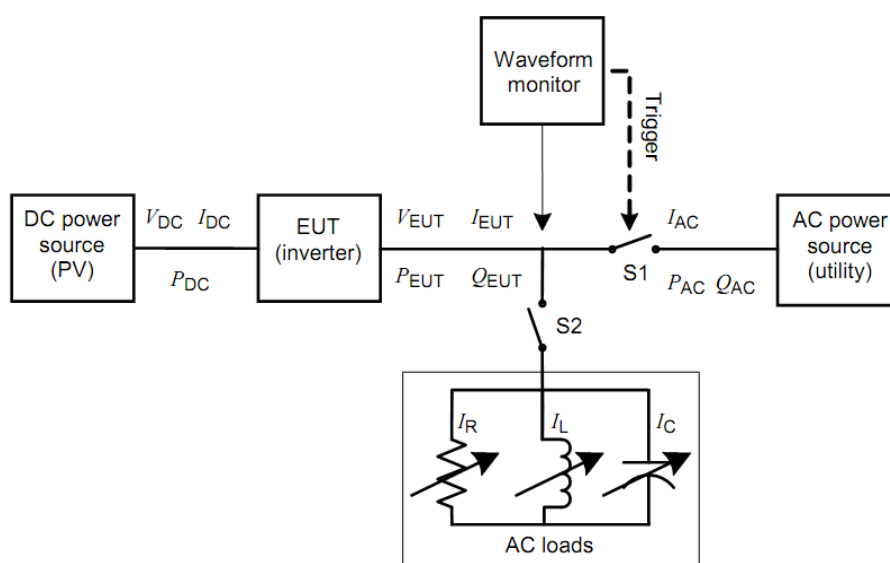

IEC 1567/08

Figure 1 – Test circuit for islanding detection function in a power conditioner (inverter)

Load imbalance (real, reactive load) for test condition A (EUT output = 100%)										P
Test : HYD 6000-EP										
Test conditions		Frequency: 50+/-0,1Hz $U_N=230+/-3V_{ac}$ Distortion factor of chokes < 2% Quality = 1								
Disconnection limit		2s (IEC 62116)								
No	$P_{EUT}^{1)}$ [% of EUT rating]	Reactive load [% of Q_L in 6,1,d) ¹⁾	$P_{AC}^{2)}$ [% of nominal]	$Q_{AC}^{3)}$ [% of nominal]	$I_{AC}^{4)}$ [A]	P_{EUT} [kW per phase]	V_{DC} [V]	Q_f	Run on Time [ms]	Remarks ⁵⁾
1	100	100	0	0	0,126	6,000	462	1,001	225	BL
2	100	100	-5	-5	1,397	6,000	462	1,027	208	IB
3	100	100	-5	0	1,430	6,000	462	1,054	216	IB
4	100	100	-5	+5	1,395	6,000	462	1,080	206	IB
5	100	100	0	-5	0,157	6,000	462	0,976	207	IB
6	100	100	0	+5	0,160	6,000	462	1,026	210	IB
7	100	100	+5	-5	1,460	6,000	462	0,929	148	IB
8	100	100	+5	0	1,430	6,000	462	0,953	208	IB
9	100	100	+5	+5	1,463	6,000	462	0,977	200	IB
Parameter at 0% per phase		L= 28,40 mH			R= 8,82 Ω			C= 361,39 μF		
Note:										
RLC is adjusted to min. +/-1% of the inverter rated output power										
1) P_{EUT} : EUT output power.										
2) P_{AC} : Real power flow at S1 in Figure 1. Positive means power from EUT to utility, Nominal is the 0 % test condition value.										
3) Q_{AC} : Reactive power flow at S1 in Figure 1. Positive means power from EUT to utility, Nominal is the 0 % test condition value.										
4) Fundamental of I_{AC} when RLC is adjusted.										
5) BL: Balance condition, IB: Imbalance condition.										
Condition A:										
EUT output power $P_{EUT} = \text{Maximum}^{6)}$										
EUT input voltage ⁶⁾ = >75% of rated input voltage range										
⁶⁾ Maximum EUT output power condition should be achieved using the maximum allowable input power, Actual output power may exceed nominal rated output.										
⁷⁾ Based on EUT rated input operating range, For example, If range is between X volts and Y volts, 75 % of range = $X + 0,75 \times (Y - X)$, Y shall not exceed $0,8 \times$ EUT maximum system voltage (i.e., maximum allowable array open circuit voltage), In any case, the EUT should not be operated outside of its allowable input voltage range.										

The tests had been performed on the HYD 6000-EP is valid for the HYD 5500-EP, HYD 5000-EP, HYD 4600-EP, HYD 4000-EP, HYD 3680-EP and HYD 3000-EP, since it is identical in hardware and software construction except output power derated by software.

The test results refer to the test report "PVTR200917N016" issued by Bureau Veritas Shenzhen Co., Ltd. Dongguan Branch, dated on 2021.01.20.

Scope pictures of the disconnection time

Disconnection at No. 1

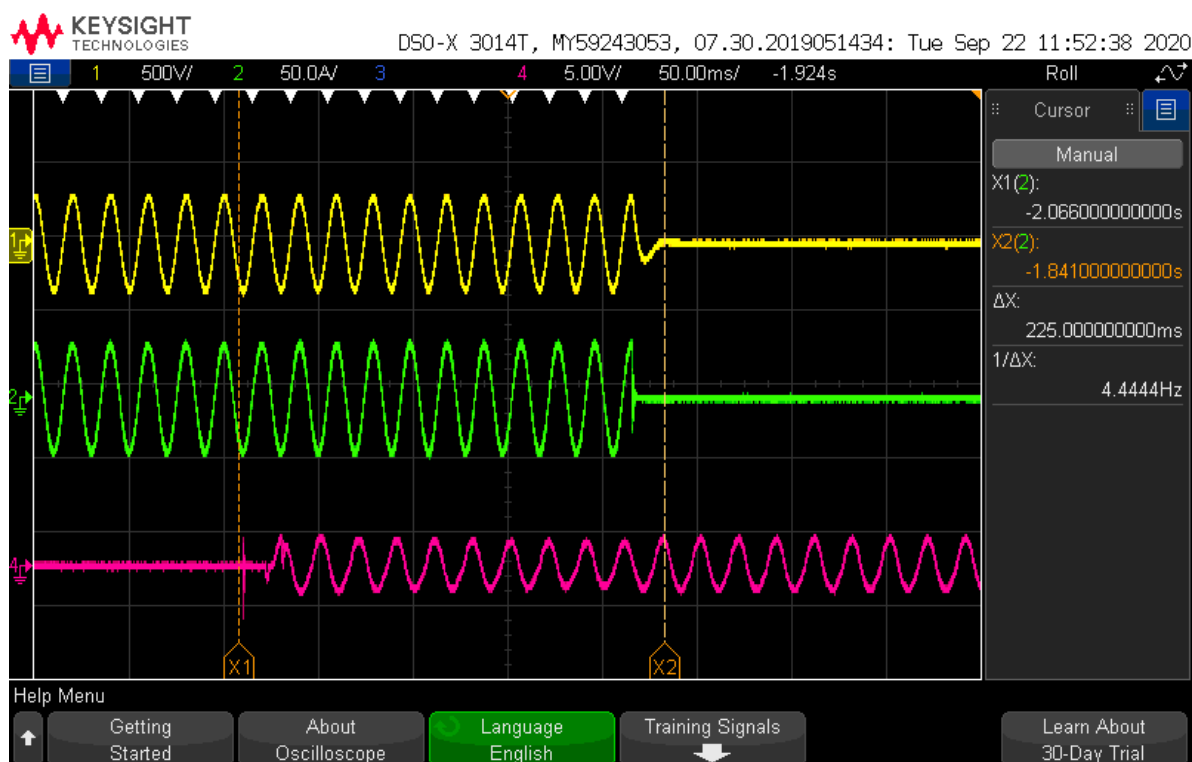

Load imbalance (reactive load) for test condition B (EUT output = 50 % – 66 %)										P
Test : HYD 6000-EP										
Test conditions			Frequency: 50+/-0,1Hz U _N =230+/-3Vac Distortion factor of chokes < 2% Quality =1							
Disconnection limit			2s (IEC 62116)							
No	P _{EUT} ¹⁾ [% of EUT rating]	Reactive load [% of Q _L in 6,1,d) ¹⁾	P _{AC} ²⁾ [% of nominal]	Q _{AC} ³⁾ [% of nominal]	I _{AC} ⁴⁾ [A]	P _{EUT} [kW per phase]	V _{DC} [V]	Q _f	Run on Time [ms]	Remarks ⁵⁾
1	66	66	0	-5	0,138	3,745	390	1,015	149	IB
2	66	66	0	-4	0,130	3,745	390	1,020	222	IB
3	66	66	0	-3	0,124	3,745	390	1,026	200	IB
4	66	66	0	-2	0,120	3,745	390	1,031	199	IB
5	66	66	0	-1	0,117	3,745	390	1,036	201	IB
6	66	66	0	0	0,116	3,745	390	1,041	232	BL
7	66	66	0	+1	0,117	3,745	390	1,047	217	IB
8	66	66	0	+2	0,120	3,745	390	1,052	203	IB
9	66	66	0	+3	0,124	3,745	390	1,057	213	IB
10	66	66	0	+4	0,130	3,745	390	1,062	215	IB
11	66	66	0	+5	0,138	3,745	390	1,067	154	IB
Parameter at 0% per phase			L= 43,19 mH		R= 14,13 Ω		C=234,58μF			
Note:										
RLC is adjusted to min. +/-1% of the inverter rated output power										
1) P _{EUT} : EUT output power.										
2) P _{AC} : Real power flow at S1 in Figure 1, Positive means power from EUT to utility, Nominal is the 0 % test condition value.										
3) Q _{AC} : Reactive power flow at S1 in Figure 1, Positive means power from EUT to utility, Nominal is the 0 % test condition value.										
4) Fundamental of I _{AC} when RLC is adjusted.										
5) BL: Balance condition, IB: Imbalance condition.										
Condition B:										
EUT output power P _{EUT} = 50 % – 66 % of maximum										
EUT input voltage ⁶⁾ = 50 % of rated input voltage range, ±10 %										
6) Based on EUT rated input operating range, For example, If range is between X volts and Y volts, 50 % of range =X + 0,5 × (Y – X), Y shall not exceed 0,8 × EUT maximum system voltage (i.e., maximum allowable array open circuit voltage), In any case, the EUT should not be operated outside of its allowable input voltage range.										

The tests had been performed on the HYD 6000-EP is valid for the HYD 5500-EP, HYD 5000-EP, HYD 4600-EP, HYD 4000-EP, HYD 3680-EP and HYD 3000-EP, since it is identical in hardware and software construction except output power derated by software.

The test results refer to the test report "PVTR200917N016" issued by Bureau Veritas Shenzhen Co., Ltd. Dongguan Branch, dated on 2021.01.20.

Scope pictures of the disconnection time

Disconnection at No. 6

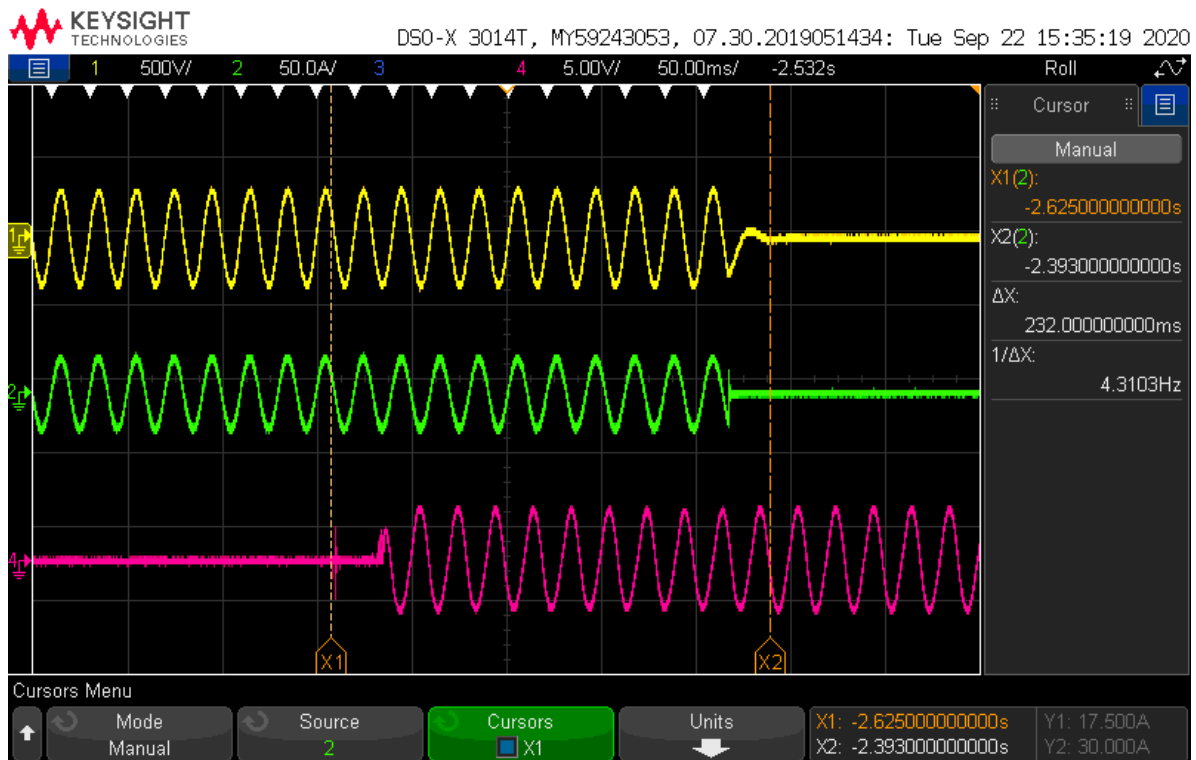

Load imbalance (reactive load) for test condition C (EUT output = 25 % – 33 %)										P
Test : HYD 6000-EP										
Test conditions		Frequency: 50+/-0,1Hz U _N =230+/-3Vac Distortion factor of chokes < 2% Quality =1								
Disconnection limit		2s (IEC 62116)								
No	P _{EUT} ¹⁾ [% of EUT rating]	Reactive load [% of Q _L in 6,1,d) ¹⁾	P _{AC} ²⁾ [% of nominal]	Q _{AC} ³⁾ [% of nominal]	I _{AC} ⁴⁾ [A]	P _{EUT} [kW per phase]	V _{DC} [V]	Q _f	Run on Time [ms]	Remarks ⁵⁾
1	33	33	0	-5	0,971	1,855	318	0,998	114	IB
2	33	33	0	-4	0,967	1,855	318	1,004	195	IB
3	33	33	0	-3	0,964	1,855	318	1,009	130	IB
4	33	33	0	-2	0,962	1,855	318	1,014	216	IB
5	33	33	0	-1	0,960	1,855	318	1,019	209	IB
6	33	33	0	0	0,960	1,855	318	1,024	221	BL
7	33	33	0	+1	0,960	1,855	318	1,029	214	IB
8	33	33	0	+2	0,962	1,855	318	1,034	211	IB
9	33	33	0	+3	0,964	1,855	318	1,040	138	IB
10	33	33	0	+4	0,967	1,855	318	1,045	195	IB
11	33	33	0	+5	0,971	1,855	318	1,050	129	IB
Parameter at 0% per phase		L= 88,65 mH			R= 28,52 Ω			C= 114,30 μF		
Note:										
RLC is adjusted to min. +/-1% of the inverter rated output power										
1) P _{EUT} : EUT output power.										
2) P _{AC} : Real power flow at S1 in Figure 1, Positive means power from EUT to utility, Nominal is the 0 % test condition value.										
3) Q _{AC} : Reactive power flow at S1 in Figure 1, Positive means power from EUT to utility, Nominal is the 0 % test condition value.										
4) Fundamental of I _{AC} when RLC is adjusted.										
5) BL: Balance condition, IB: Imbalance condition.										
Condition B:										
EUT output power P _{EUT} = 25 % – 33 % ⁶⁾ of maximum										
EUT input voltage ⁷⁾ = <20 % of rated input voltage range										
6) Or minimum allowable EUT output level if greater than 33 %.										
7) Based on EUT rated input operating range, For example, If range is between X volts and Y volts, 20 % of range = X + 0,2 × (Y – X), Y shall not exceed 0,8 × EUT maximum system voltage (i.e., maximum allowable array open circuit voltage), In any case, the EUT should not be operated outside of its allowable input voltage										

range.

The tests had been performed on the HYD 6000-EP is valid for the HYD 5500-EP, HYD 5000-EP, HYD 4600-EP, HYD 4000-EP, HYD 3680-EP and HYD 3000-EP, since it is identical in hardware and software construction except output power derated by software.

The test results refer to the test report "PVTR200917N016" issued by Bureau Veritas Shenzhen Co., Ltd. Dongguan Branch, dated on 2021.01.20.

Scope pictures of the disconnection time

Disconnection at No. 6

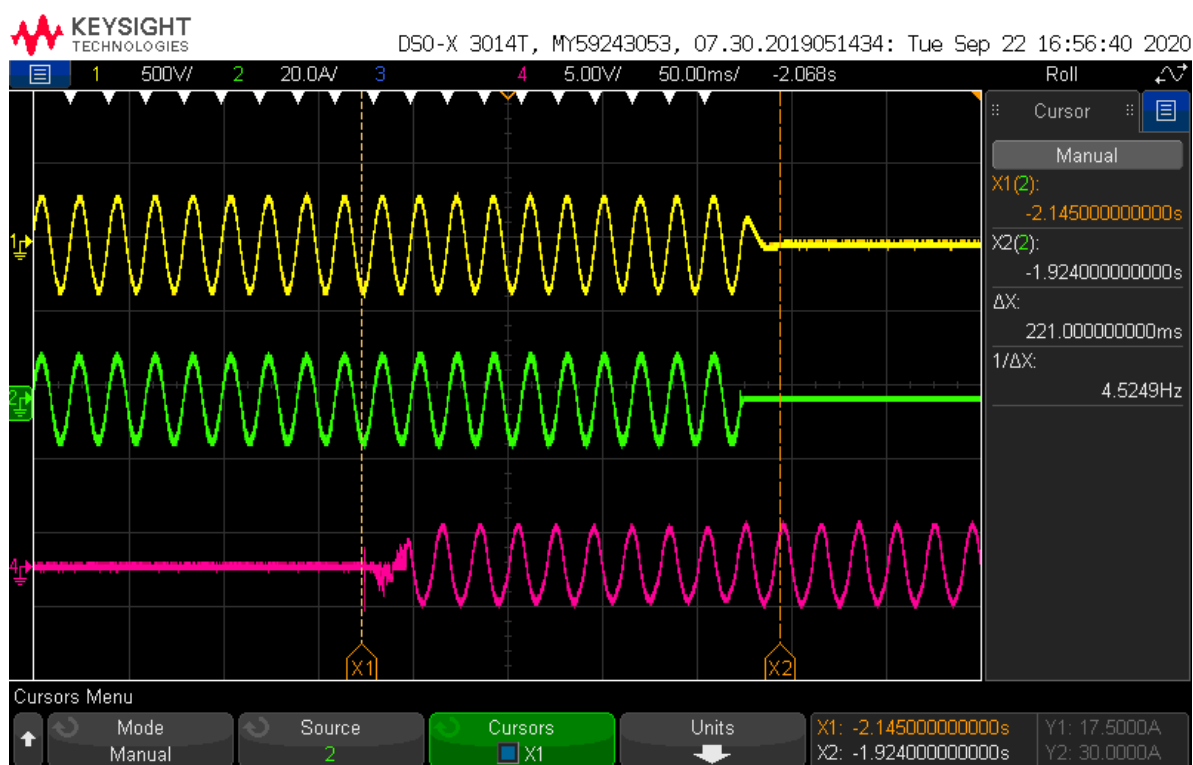

EN 50549-1:2019: Connection and starting to generate electrical power

Clause	Test requirement	Test procedure according standard	Result
4.10.2	Automatic reconnection after tripping	EN 50438, Annex D.3.6	P
4.10.3	Starting to generate electrical power	EN 50438, Annex D.3.6	P

4.10	Connection and starting to generate electrical power		P
4.10.2	Automatic reconnection after tripping		
4.10.3	Starting to generate electrical power (Setting value refer EN 50438 Default setting)		
Setting value	Min. voltage for connected to grid :	196 V	
	Max. voltage for connected to grid :	253 V	
	Min. frequency for connected to grid :	49,5 Hz	
	Max. frequency for connected to grid (Normal operational start-up) :	50,1 Hz	
	Max. frequency for connected to grid (Automatic reconnection after tripping) :	50,2 Hz	
	Observation time ($\geq 60s$) :	60 s	
Test:			
	Voltage conditons		
a) Start up for voltage range	<85% U_n for twice of observation time	>110% U_n for twice of observation time	
Connection:	No connection		No connection
Limit	No connection allowed		
b) In voltage range at start-up	$\geq 85\% U_n$ within twice setting observation time	$\leq 110\% U_n$ within twice setting observation time	
Reconnection time [s]	65 s		65 s
Limit:	Connected after setting observation time ($\geq 60s$)		
Gradient:	The maximum occurring active power gradient after connection respectively start generating electrical power is less than the configured maximum active power per minute Max gradient: disable, For recorded gradient see diagram below,		
c) In voltage range after voltage failure	$\geq 85\% U_n$ for twice of setting observation time	$\leq 110\% U_n$ for twice of setting observation time	
Reconnection time [s]	65 s		65 s
Limit:	Reconnection after setting observation time ($\geq 60s$)		
Gradient:	For adjustable micro generators the maximum occurring active power gradient after connection respectively start generating electrical power is less than the configured maximum active power per minute Max gradient: $10\%P_{E_{max}}/\text{min}$. For non or partly adjustable generators the connection after trip of the interface protection is delayed by a randomised value between 1 min and 10 min. For recorded gradient see diagram below.		

	Frequency conditions	
d) Start up for frequency range	<49,50 Hz for twice of setting observation time	>50,10 Hz for twice of setting observation time
Connection:	No connection	No connection
Limit	No connection allowed	
e) In frequency range at start-up	≥49,50 Hz within twice of setting observation time	≤50,10 Hz within twice of setting observation time
Reconnection time [s]	65 s	65 s
Limit:	Connected after setting delay time(≥60s)	
Gradient:	The maximum occurring active power gradient after connection respectively start generating electrical power is less than the configured maximum active power per minute Max gradient: disable. For recorded gradient see diagram below.	
f) In frequency range after frequency failure	≥49,50 Hz for twice of setting observation time	≤50,20 Hz for twice of setting observation time
Reconnection time [s]	65 s	65 s
Limit:	Reconnection after setting observation time (≥60s)	
Gradient:	For adjustable micro generators the maximum occurring active power gradient after connection respectively start generating electrical power is less than the configured maximum active power per minute Max gradient: 10%P _{E_{max}} /min. For non or partly adjustable generators the connection after trip of the interface protection is delayed by a randomised value between 1 min and 10 min. For recorded gradient see diagram below.	
Test:	<p>Test condition b) and c): voltage within the limits of 85% to 110%U_n.</p> <p>Test condition e): frequency within the limits of 49,50Hz to 50,1Hz.</p> <p>Test condition f): frequency within the limits of 49,50Hz to 50,2Hz.</p> <p>In order to avoid continuous starting and disengaging operations of the interface protection relay, the disengaging value of frequency and voltage functions shall be above 2 % deviating from the operate value.</p> <p>The tests had been performed on the HYD 6000-EP is valid for the HYD 5500-EP, HYD 5000-EP, HYD 4600-EP , HYD 4000-EP, HYD 3680-EP and HYD 3000-EP, since it is identical in hardware and software construction except output power derated by software.</p>	
Assessment criterion:	<p>a) the micro generator connects respectively starts generating electrical power only in the permitted range of voltage and frequency and</p> <p>b) for adjustable micro generators the maximum occurring active power gradient after connection respectively start generating electrical power is less than the configured maximum active power per minute and</p> <p>c) for non or partly adjustable generators the connection after trip of the interface protection is delayed by a randomised value between 1 min and 10 min.</p>	

Graph of the gradual power supply : Test b) for $\geq 85\% U_n$

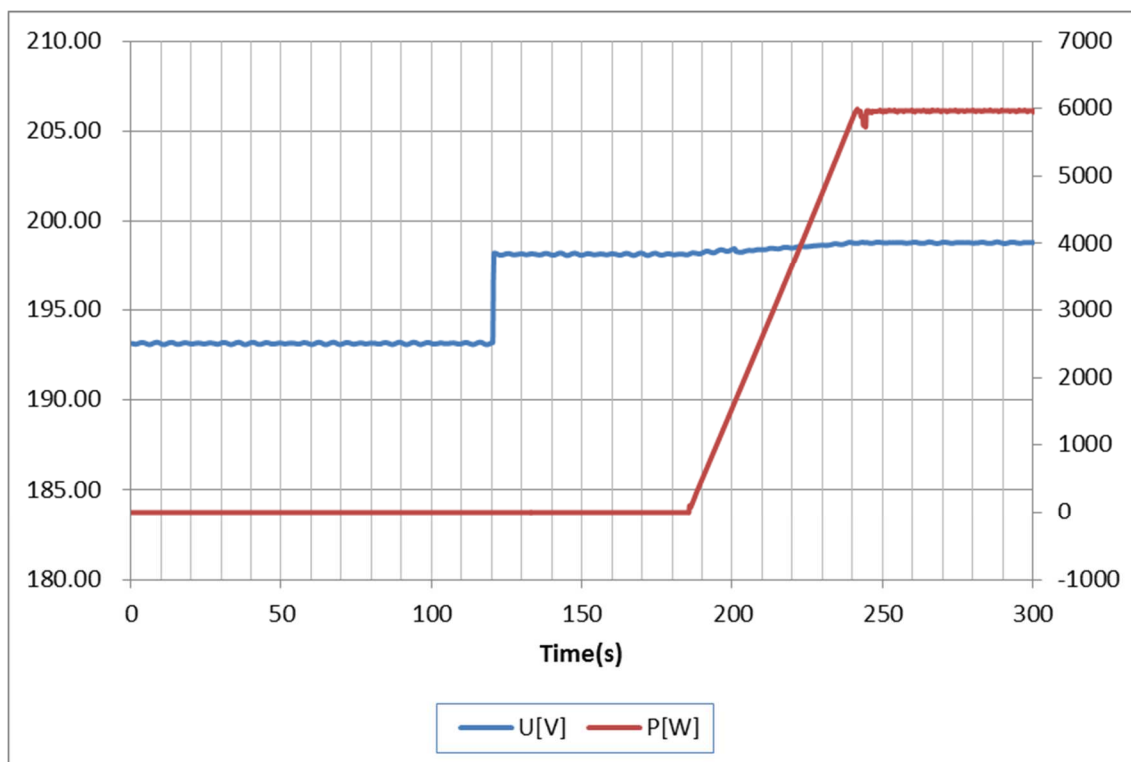

Graph of the gradual power supply : Test b) for $\leq 110\% U_n$

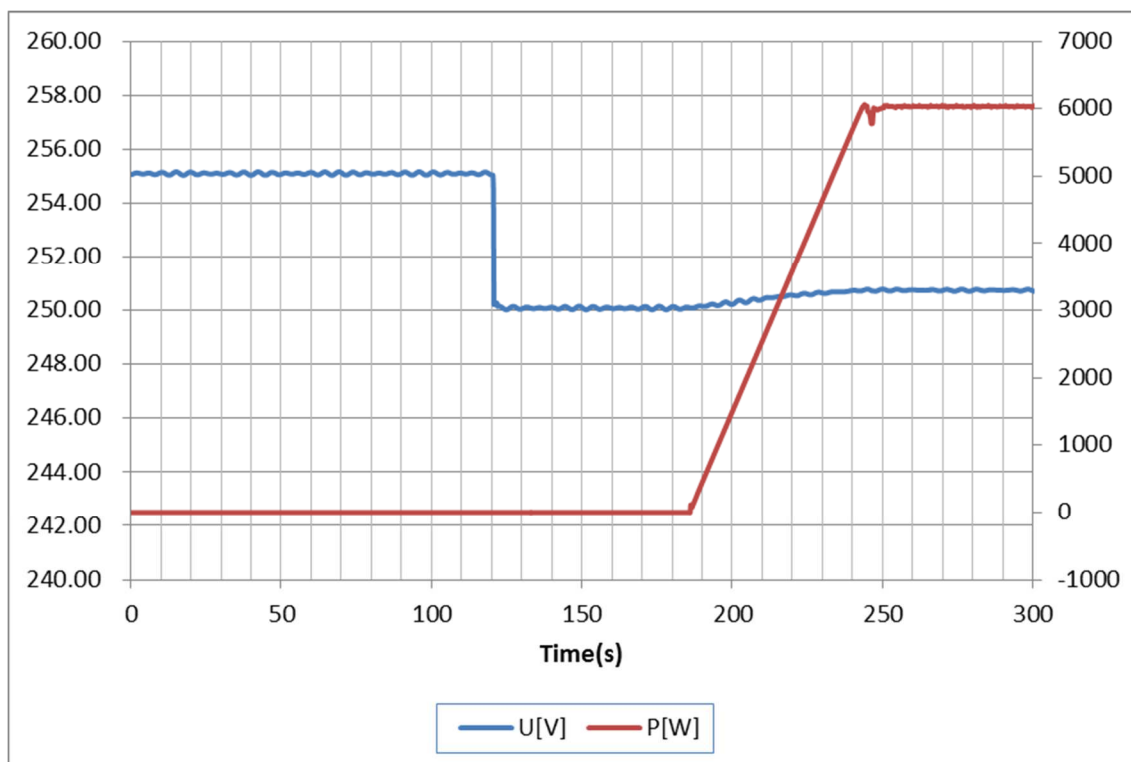

Graph of the gradual power supply : Test c) for $\geq 85\% U_n$

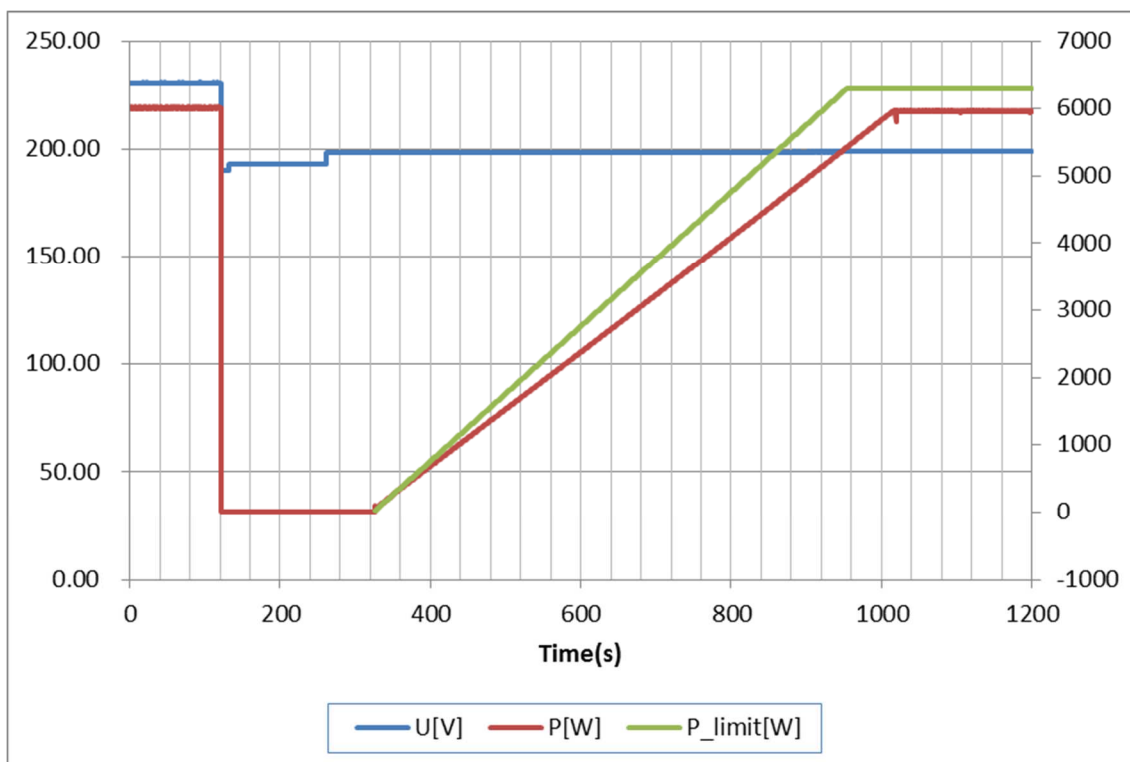

Graph of the gradual power supply : Test c) for $\leq 110\% U_n$

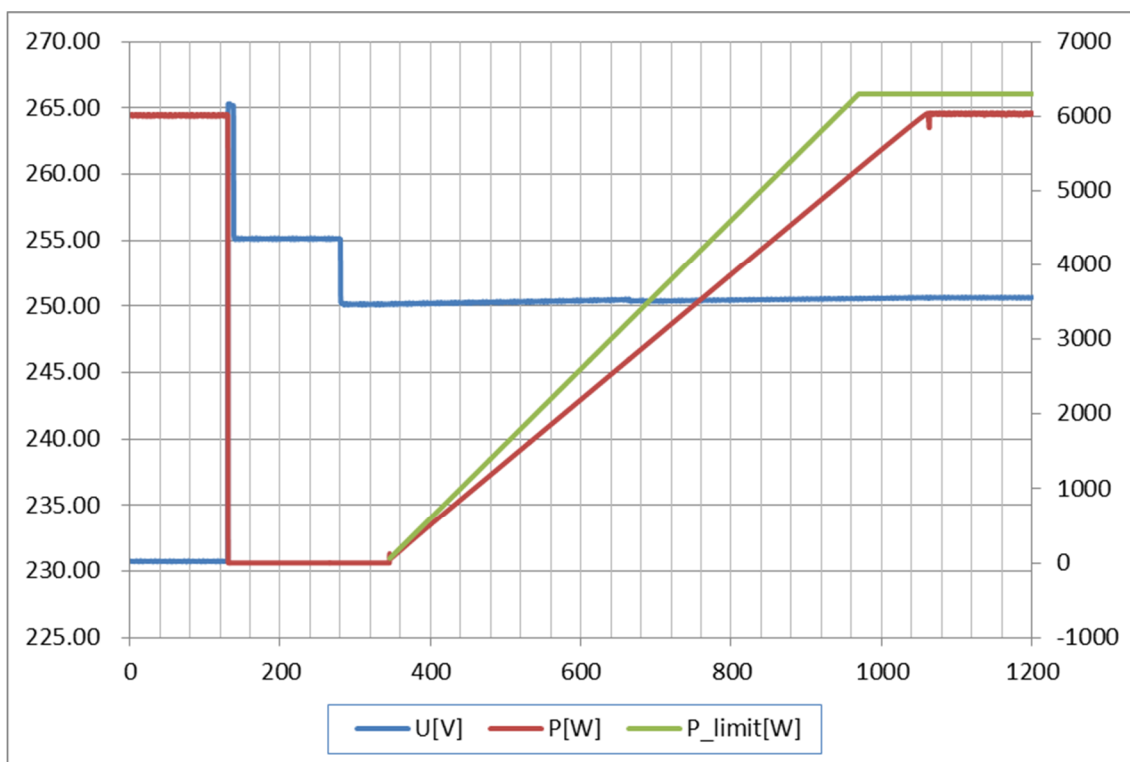

Graph of the gradual power supply : Test d) e) for $\geq 49,50\text{Hz}$

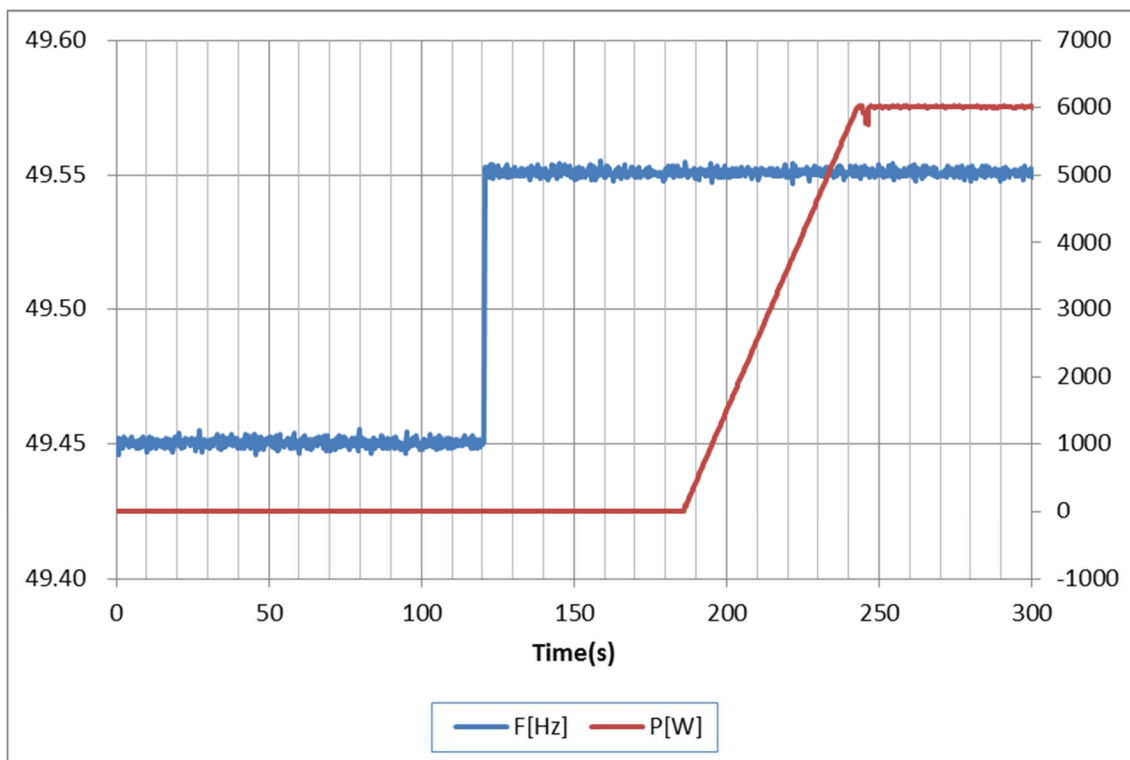

Graph of the gradual power supply : Test e) for $\leq 50,10\text{Hz}$

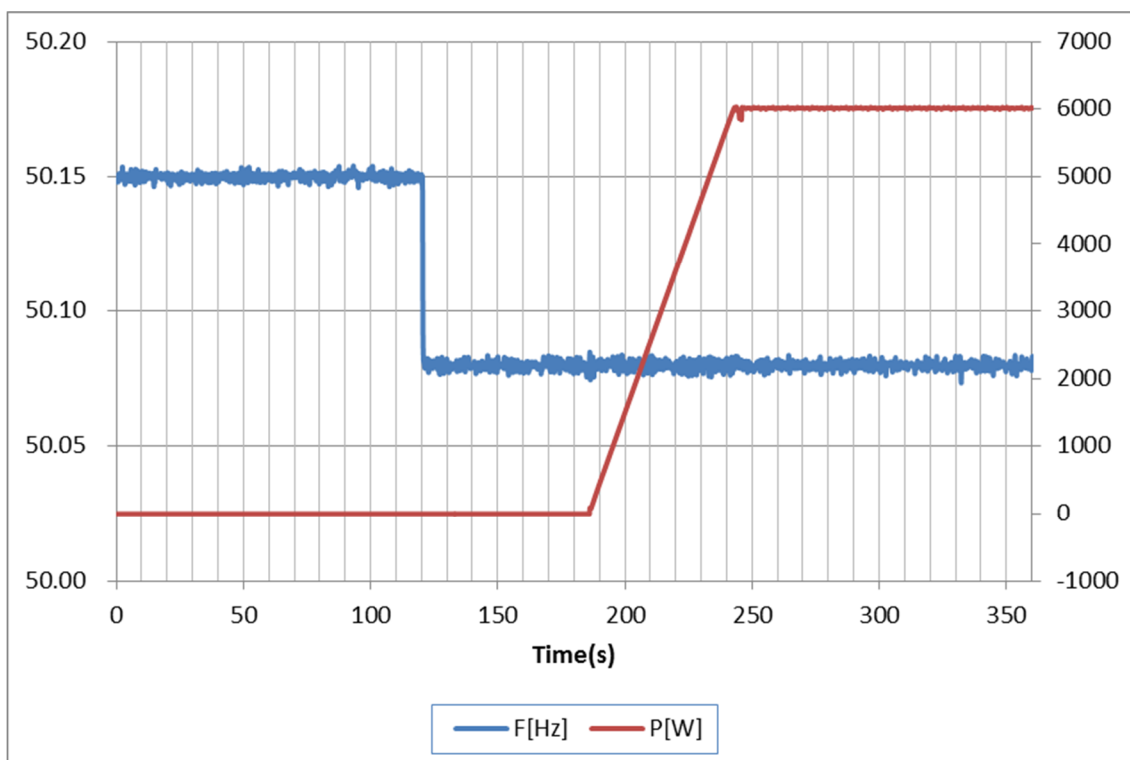

Graph of the gradual power supply : Test f) for $\geq 49,50\text{Hz}$

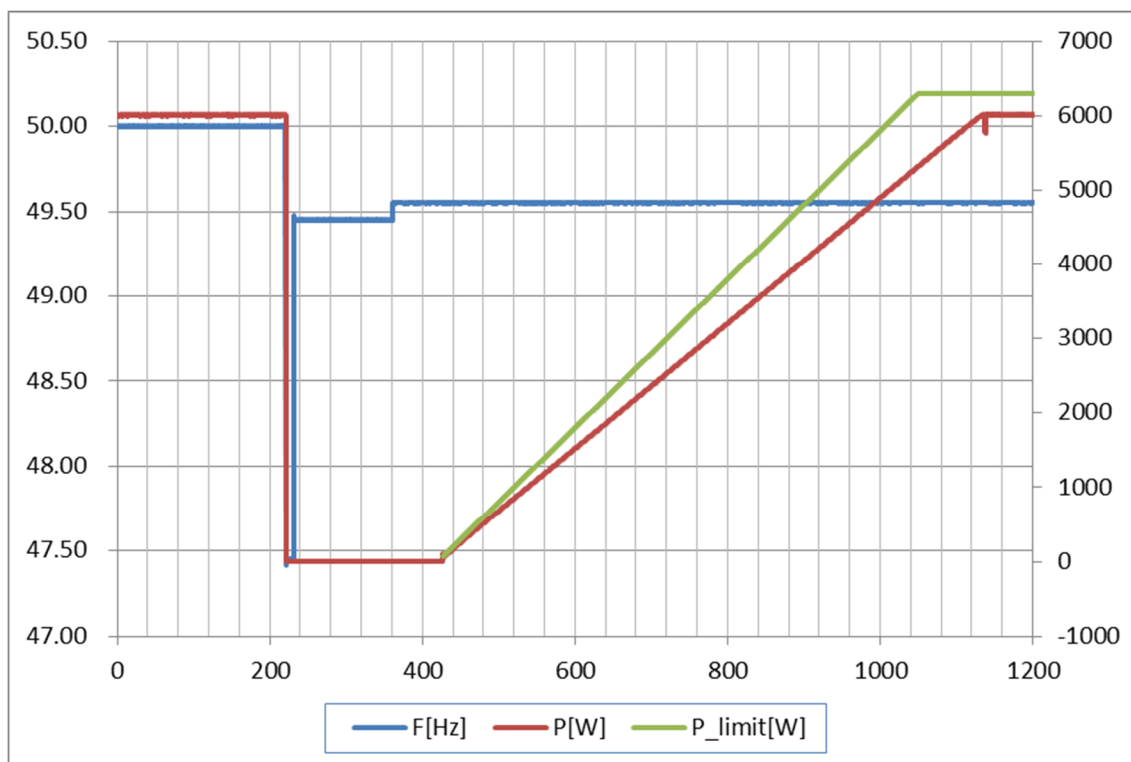

Graph of the gradual power supply : Test f) for $\leq 50,20\text{Hz}$

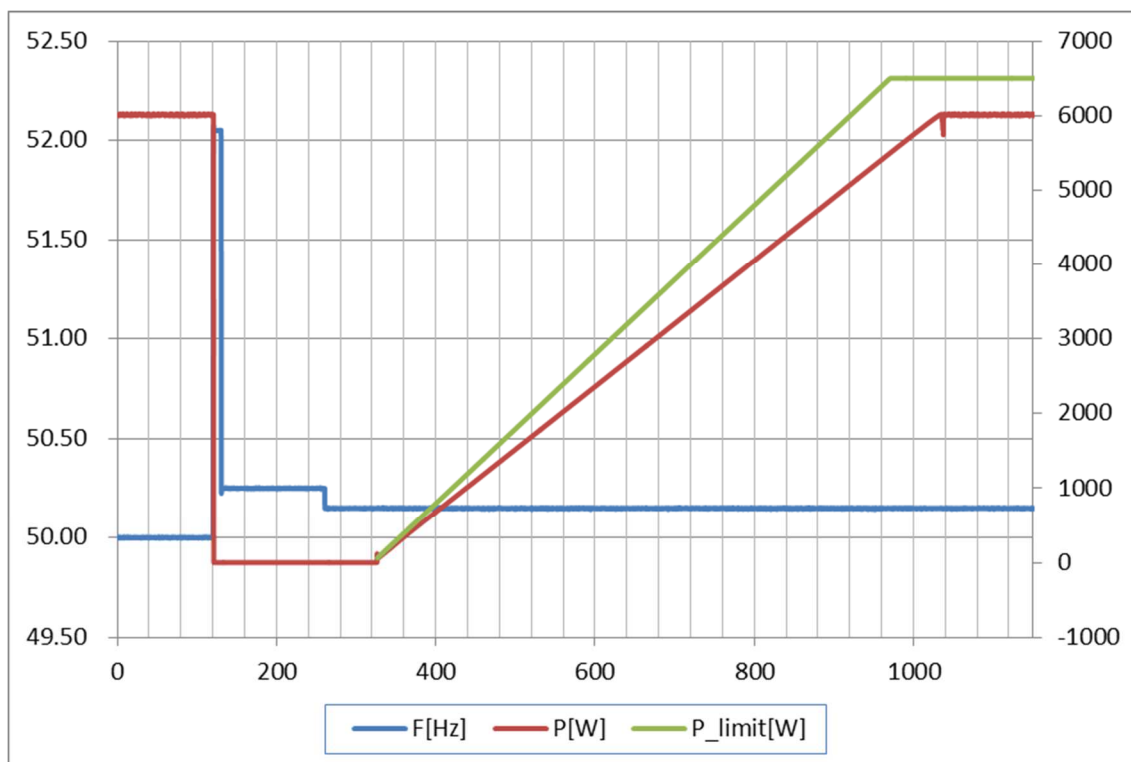

EN 50549-1:2019: Ceasing and reduction of active power on set point

Clause	Test requirement	Test procedure according standard	Result
4.11.1	Ceasing active power	CEI 0-21:2019-04, Annex A.4.3.3.2	P
4.11.2	Reduction of active power on a set point	FGW TG3, Revision 25, clause 4.1.2	P

4.11.1	Ceasing active power	P
---------------	-----------------------------	----------

Operating time of the monitoring device	
Test:	Remote tripping signal for the external disconnection
Limit [s]:	5 s
Reaction time of the tripping value [s]:	0,095 s

Note:
 The test method refer to Annex A,4,3,2 of CEI 0-21:2019-04.
 Generating plants shall be equipped with a logic interface (input port) in order to cease active power output within five seconds following an instruction being received at the input port, If required by the DSO, this includes remote operation.
 The tests had been performed on the HYD 6000-EP is valid for the HYD 5500-EP, HYD 5000-EP, HYD 4600-EP , HYD 4000-EP, HYD 3680-EP and HYD 3000-EP, since it is identical in hardware and software construction except output power derated by software.
 The test results refer to the test report "PVTR200917N016" issued by Bureau Veritas Shenzhen Co., Ltd. Dongguan Branch, dated on 2021.01.20.

Graph of Remote trip signal :

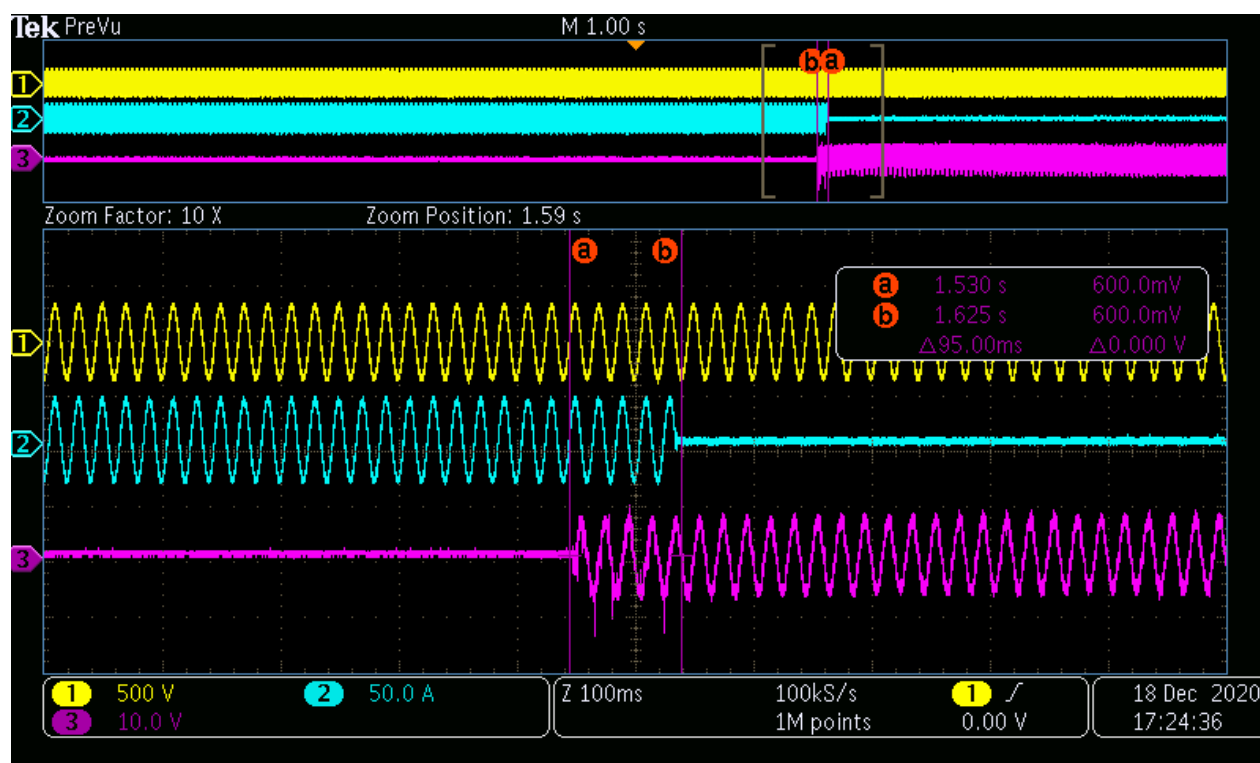

4.11.2 Reduction of active power on set point			P
Test result:			
Setpoint power bin [%P _{E_{max}}]	P _{set} [kW]	P ₆₀ [kW]	Deviation [%P _{E_{max}}]
100%	6,000	6,001	0,023
90%	5,400	5,465	1,087
80%	4,800	4,858	0,968
70%	4,200	4,253	0,884
60%	3,600	3,648	0,806
50%	3,000	3,050	0,829
40%	2,400	2,445	0,749
30%	1,800	1,845	0,751
20%	1,200	1,246	0,771
10%	0,600	0,647	0,777
	Setpoint power bin [%P _{E_{max}}]	Deviation [%P _{E_{max}}]	
Max. deviation	90%	1,087	
Limit $\Delta P_{E60}/P_{Setpoint}$:	+ 5 % of P _{E_{max}}		
Test:			
The setpoint signal must be reduced from 100% to 10% P _{E_{max}} :			
a) for adjustable PGUs in increments of 10% P _{E_{max}} , 1 minute must elapse after every change to the setpoint setting so that the PGU can settle at the new setpoint, Then the active power of the PGU must be measured as a 1-min mean value.			
b) For all other PGUs, in line with their adjustable steps, 5 minutes must elapse after the setpoint setting is changed so that the PGU can settle at the new setpoint, Then the active power of the PGU must be measured as a 1-min mean value.			
Assessment criterion:			
a) for adjustable PGUs:			
- no network disconnection			
- the active power value does not exceed the setpoint by more than 5% P _{E_{max}}			
- the setting time determined this way is ≤ 1 min			
b) For all other PGUs:			
- the active power value does not exceed the setpoint by more than 5% P _{E_{max}} or			
- the setpoint is fallen below within 5 minutes or the PGU has switched off			

Note:

The setting time is ≤ 1 min. See below "Graph of the setting accuracy".

The tests had been performed on the HYD 6000-EP is valid for the HYD 5500-EP, HYD 5000-EP, HYD 4600-EP, HYD 4000-EP, HYD 3680-EP and HYD 3000-EP, since it is identical in hardware and software construction except output power derated by software.

The test results refer to the test report "PVTR200917N016" issued by Bureau Veritas Shenzhen Co., Ltd. Dongguan Branch, dated on 2021.01.20.

Graph of active power on set point

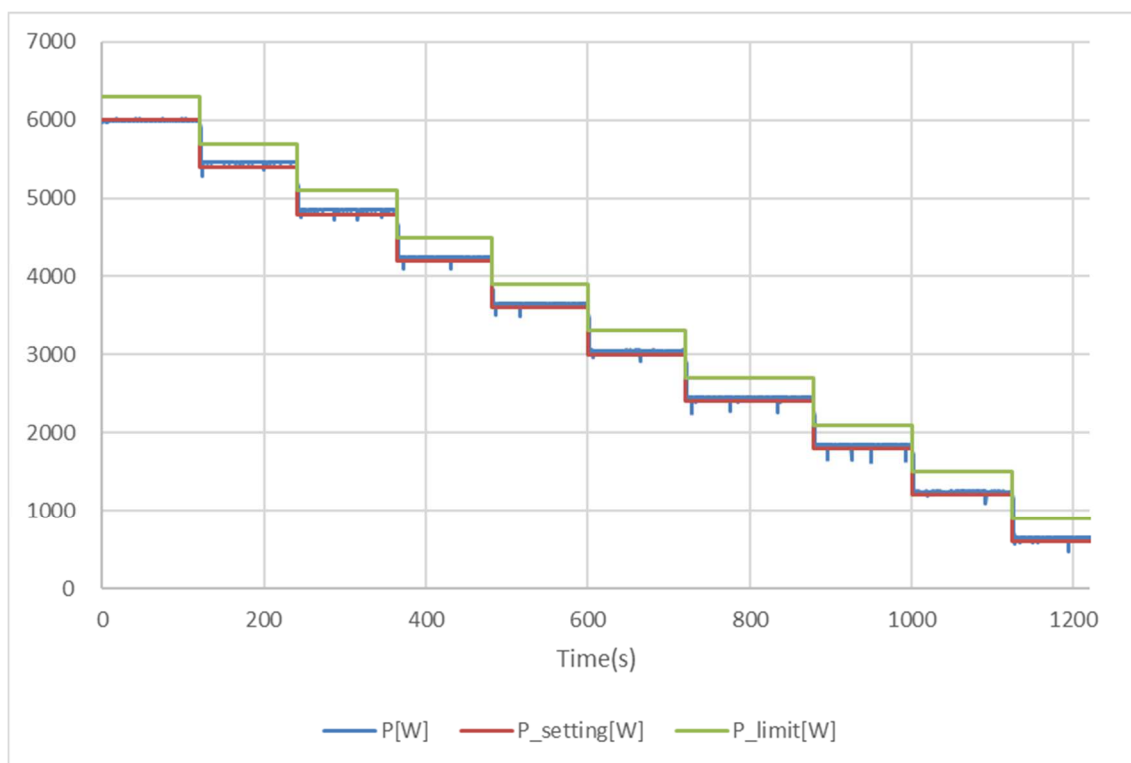

EN 50549-1:2019

Clause	Test requirement	Test procedure according standard	Result
4.13	Requirements regarding single fault tolerance of interface protection system and interface switch	VDE V 0124-100:2019-02 (Draft), clause 5.5.2	P

4.13 Requirements regarding single fault tolerance of interface protection system and interface switch								P
Component No.	Fault	Test condition		Test time	Fuse No,	Fault condition		Result
		AC	DC			AC	DC	
Relay RL4	Short before start-up	230V <1A	520V <1A	10Min.	--	230V <1A	520V <1A	Indicate Relay fault,error code "ID41: RecoverRelayFail". Do not connect to AC mainsn. No damage,no hazards.
Relay RL1	Short before start-up	230V <1A	520V <1A	10Min.	--	230V <1A	520V <1A	Indicate Relay fault,error code "ID41: RecoverRelayFail". Do not connect to AC mainsn. No damage,no hazards.
Relay RL2	Short before start-up	230V <1A	520V <1A	10Min.	--	230V <1A	520V <1A	Indicate Relay fault,error code "ID41: RecoverRelayFail". Do not connect to AC mainsn. No damage,no hazards.
Relay RL5	Short before start-up	230V <1A	520V <1A	10Min.	--	230V <1A	520V <1A	Indicate Relay fault,error code "ID41: RecoverRelayFail". Do not connect to AC mainsn. No damage,no hazards.
Rectifier bridge BR1	Short	230V 15,5A	520V 11,8A	10Min.	--	230V <1A	520V <1A	Output a.c. relays operated immediately, disconnected with grid. No damage, no hazards.
Q23 pin G-S	Short	230V 15,5A	520V 11,8A	10Min.	--	230V <1A	520V <1A	Output a.c. relays operated, disconnected with grid. error code "ID41: RecoverRelayFail". No damage,no hazards.
Q17 pin G-S	Short	230V 15,5A	520V 11,8A	10Min.	--	230V <1A	520V <1A	Output a.c. relays operated, disconnected with grid. error code "ID41: RecoverRelayFail". No damage,no hazards.
Q18 pin G-S	Short	230V 15,5A	520V 11,8A	10Min.	--	230V <1A	520V <1A	Output a.c. relays operated, disconnected with grid. error code "ID41: RecoverRelayFail". No damage,no hazards.

Component No.	Fault	Test condition		Test time	Fuse No,	Fault condition		Result
		AC	DC			AC	DC	
Q16 pin G-S	Short	230V 15,5A	520V 11,8A	10Min.	--	230V <1A	520V <1A	Output a.c. relays operated, disconnected with grid. error code "ID41: RecoverRelayFail". No damage,no hazards.
RCM/LP1 pin GND-Vout	Short	230V 15,5A	520V 11,8A	10Min.	--	230V <1A	520V <1A	Output a.c. relays operated, disconnected with grid. error code "ID05:GFCI fault". No damage,no hazards.
Monitoring voltage defect R203	Open	230V 15,5A	520V 11,8A	10Min.	--	230V <1A	520V <1A	Output a.c. relays operated, disconnected with grid, error code "GridUVP". No damage. No hazards.
Monitoring voltage defect R219	Open	230V 15,5A	520V 11,8A	10Min.	--	230V <1A	520V <1A	Output a.c. relays operated, disconnected with grid, error code "GridUVP". No damage. No hazards.
U1 pin 485-1TX 485-1RX	Short	230V 15,5A	520V 11,8A	10Min.	--	230V <1A	520V <1A	Output a.c. relays operated, disconnected with grid. 4851 Communication failure. No damage. No hazards.
U1 pin 485-2TX 485-2RX	Short	230V 15,5A	520V 11,8A	10Min.	--	230V <1A	520V <1A	Output a.c. relays operated, disconnected with grid. 4852 Communication failure. No damage. No hazards.
U1 pin ARMTtoDSP ARMFromDSP-TX	Short	230V 15,5A	520V 11,8A	10Min.	--	230V <1A	520V <1A	Output a.c. relays operated, disconnected with grid. SCI Communication failure. No damage. No hazards.
U1 pin M_CAN_RX M_CAN_TX	Short	230V 15,5A	520V 11,8A	10Min.	--	230V <1A	520V <1A	Output a.c. relays operated, disconnected with grid. CAN Communication failure. No damage. No hazards.
U1,+3.3V.S	Open	230V 15,5A	520V 11,8A	10Min.	--	230V <1A	520V <1A	Output a.c. relays operated, disconnected with grid. SCI Communication failure. No damage. No hazards.

Component No.	Fault	Test condition		Test time	Fuse No,	Fault condition		Result
		AC	DC			AC	DC	
PV voltage monitoring R283	Open	230V 15,5A	520V 11,8A	10Min.	--	230V <1A	520V <1A	Output a.c. relays operated, disconnected with grid. No damage. No hazards
PV voltage monitoring R277	Open	230V 15,5A	520V 11,8A	10Min.	--	230V <1A	520V <1A	Output a.c. relays operated, disconnected with grid. No damage. No hazards
L to N(Grid)	Reversed	230V 15,5A	520V 11,8A	10Min.	--	230V 15,5A	520V 11,8A	EUT operationed normally. No damage, no hazards.
C324	Short	230V 15,5A	520V 11,8A	10Min.	--	230V <1A	520V <1A	Output a.c. relays operated, disconnected with grid. L2 ,L7,breakdown, no hazards.
EC2	Short	230V 15,5A	520V 11,8A	10Min.	--	230V <1A	520V <1A	Output a.c. relays operated, disconnected with grid. EC2 damage, no hazards.
EC3	Short	230V 15,5A	520V 11,8A	10Min.	--	230V <1A	520V <1A	Output a.c. relays operated, disconnected with grid. EC3 damage, no hazards.
Q61 pin D-S	Short	230V 15,5A	520V 11,8A	10Min.	--	230V <1A	520V <1A	Output a.c. relays operated, disconnected with grid. No damage. No hazards
Q16 pin D-S	Short	230V 15,5A	520V 11,8A	10Min.	--	230V <1A	520V <1A	Output a.c. relays operated, disconnected with grid, error code "ID81" (SwBatOCP). No damage, no hazards.
Q17 pin D-S	Short	230V 15,5A	520V 11,8A	10Min.	--	230V <1A	520V <1A	Output a.c. relays operated, disconnected with grid, error code "ID81" (SwBatOCP). No damage, no hazards.
Q18 pin D-S	Short	230V 15,5A	520V 11,8A	10Min.	--	230V <1A	520V <1A	Output a.c. relays operated, disconnected with grid, error code "ID81" (SwBatOCP). No damage, no hazards.
Q19 pin D-S	Short	230V 15,5A	520V 11,8A	10Min.	--	230V <1A	520V <1A	Output a.c. relays operated, disconnected with grid, error code "ID81" (SwBatOCP). No damage, no hazards.

Component No.	Fault	Test condition		Test time	Fuse No,	Fault condition		Result
		AC	DC			AC	DC	
D13	Short	230V 15,5A	520V 11,8A	10Min.	--	230V <1A	520V <1A	Output a.c. relays operated, disconnected with grid, error code " ID69.PVOVP". No damage, no hazards.
R28	Open	230V 15,5A	520V 11,8A	10Min.	--	230V <1A	520V <1A	Output a.c. relays operated, disconnected with grid, error code " ID69.PVOVP". No damage, no hazards.
R68	Open	230V 15,5A	520V 11,8A	10Min.	--	230V <1A	520V <1A	Output a.c. relays operated, disconnected with grid, error code " ID71 LLCBusOVP". No damage, no hazards.
R32	Open	230V 15,5A	520V 11,8A	10Min.	--	230V <1A	520V <1A	Output a.c. relays operated, disconnected with grid, error code " ID71 LLCBusOVP". No damage, no hazards.
R71	Open	230V 15,5A	520V 11,8A	10Min.	--	230V <1A	520V <1A	Output a.c. relays operated, disconnected with grid, error code " ID71 LLCBusOVP". No damage, no hazards.
Q27	Short	230V 15,5A	520V 11,8A	10Min.	--	230V <1A	520V <1A	Output a.c. relays operated, disconnected with grid, error code " ID71 LLCBusOVP". No damage, no hazards.
Q9 pin G-C-E	Short	230V 15,5A	520V 11,8A	10Min.	--	230V <1A	520V <1A	The EUT shut down immediately. Q9,Q13 damaged, no hazards
Q8 pin G-C-E	Short	230V 15,5A	520V 11,8A	10Min.	--	230V <1A	520V <1A	The EUT shut down immediately. Q8,Q14 damaged, no hazards
Q7 pin G-C	Short	230V 15,5A	520V 11,8A	10Min.	--	230V <1A	520V <1A	The EUT shut down immediately. Q7 damaged, no hazards
Q12 pin G-C	Short	230V 15,5A	520V 11,8A	10Min.	--	230V <1A	520V <1A	The EUT shut down immediately. Q12 damaged, no hazards
Q1 pin G-S-D	Short	230V 15,5A	520V 11,8A	10Min.	--	230V <1A	520V <1A	The EUT shut down immediately. Q1,Q2,Q3 damaged, no hazards

Component No.	Fault	Test condition		Test time	Fuse No,	Fault condition		Result
		AC	DC			AC	DC	
Q2 pin G-S-D	Short	230V 15,5A	520V 11,8A	10Min.	--	230V <1A	520V <1A	The EUT shut down immediately. Q1,Q2,Q3,Q6 damaged, no hazards
R531	Short	230V 15,5A	520V 11,8A	10Min.	--	230V <1A	520V <1A	Output a.c. relays operated, disconnected with grid, error code " ID42,IsoFault". No damage, no hazards.
R602	Short	230V 15,5A	520V 11,8A	10Min.	--	230V <1A	520V <1A	Output a.c. relays operated, disconnected with grid, error code " ID42,IsoFault". No damage, no hazards.
R611	Short	230V 15,5A	520V 11,8A	10Min.	--	230V <1A	520V <1A	Output a.c. relays operated, disconnected with grid, error code " ID42,IsoFault". No damage, no hazards.
R620	Short	230V 15,5A	520V 11,8A	10Min.	--	230V <1A	520V <1A	Output a.c. relays operated, disconnected with grid, error code " ID42,IsoFault". No damage, no hazards.
EC25	Short	230V 15,5A	520V 11,8A	10Min.	--	230V <1A	520V <1A	Output a.c. relays operated, disconnected with grid, error code " ID42,IsoFault". No damage, no hazards.
EC27	Short	230V 15,5A	520V 11,8A	10Min.	--	230V <1A	520V <1A	Output a.c. relays operated, disconnected with grid, error code " ID17HwADFaultIGrid". No damage, no hazards.
EC16	Short	230V 15,5A	520V 11,8A	10Min.	--	230V <1A	520V <1A	Output a.c. relays operated, disconnected with grid, error code " ID17HwADFaultIGrid". No damage, no hazards.
EC17	Short	230V 15,5A	520V 11,8A	10Min.	--	230V <1A	520V <1A	Output a.c. relays operated, disconnected with grid, error code " ID17HwADFaultIGrid". No damage, no hazards.
EC29	Short	230V 15,5A	520V 11,8A	10Min.	--	230V <1A	520V <1A	Output a.c. relays operated, disconnected with grid, error code " ID17HwADFaultIGrid". No damage, no hazards.
EC31	Short	230V 15,5A	520V 11,8A	10Min.	--	230V <1A	520V <1A	Output a.c. relays operated, disconnected with grid, error code " ID17HwADFaultIGrid". No damage, no hazards.

Component No.	Fault	Test condition		Test time	Fuse No,	Fault condition		Result
		AC	DC			AC	DC	
EC18	Short	230V 15,5A	520V 11,8A	10Min.	--	230V <1A	520V <1A	Output a.c. relays operated, disconnected with grid, error code " ID17HwADFaultGrid". No damage, no hazards.
EC19	Short	230V 15,5A	520V 11,8A	10Min.	--	230V <1A	520V <1A	Output a.c. relays operated, disconnected with grid, error code " ID17HwADFaultGrid". No damage, no hazards.
EC24	Short	230V 15,5A	520V 11,8A	10Min.	--	230V <1A	520V <1A	Output a.c. relays operated, disconnected with grid, error code " ID17HwADFaultGrid". No damage, no hazards.
EC26	Short	230V 15,5A	520V 11,8A	10Min.	--	230V <1A	520V <1A	Output a.c. relays operated, disconnected with grid, error code " ID17HwADFaultGrid". No damage, no hazards.
EC20	Short	230V 15,5A	520V 11,8A	10Min.	--	230V <1A	520V <1A	Output a.c. relays operated, disconnected with grid, error code " ID17HwADFaultGrid". No damage, no hazards.
EC21	Short	230V 15,5A	520V 11,8A	10Min.	--	230V <1A	520V <1A	Output a.c. relays operated, disconnected with grid, error code " ID17HwADFaultGrid". No damage, no hazards.
EC28	Short	230V 15,5A	520V 11,8A	10Min.	--	230V <1A	520V <1A	Output a.c. relays operated, disconnected with grid, error code " ID17HwADFaultGrid". No damage, no hazards.
EC30	Short	230V 15,5A	520V 11,8A	10Min.	--	230V <1A	520V <1A	Output a.c. relays operated, disconnected with grid, error code " ID17HwADFaultGrid". No damage, no hazards.
EC22	Short	230V 15,5A	520V 11,8A	10Min.	--	230V <1A	520V <1A	Output a.c. relays operated, disconnected with grid, error code " ID17HwADFaultGrid". No damage, no hazards.
EC23	Short	230V 15,5A	520V 11,8A	10Min.	--	230V <1A	520V <1A	Output a.c. relays operated, disconnected with grid, error code " ID17HwADFaultGrid". No damage, no hazards.

Component No.	Fault	Test condition		Test time	Fuse No,	Fault condition		Result
		AC	DC			AC	DC	
EC32	Short	230V 15,5A	520V 11,8A	10Min.	--	230V <1A	520V <1A	Output a.c. relays operated, disconnected with grid, error code "SCI Communication failure". No damage, no hazards.
U4 pin M_LINRX M_LINTX	Short	230V 15,5A	520V 11,8A	10Min.	--	230V <1A	520V <1A	Output a.c.relays operated, disconnected with grid. M_LINRX Communication failure No damaged. No hazards
INSYN,TX1,IN SYN,RX1	Short	230V 15,5A	520V 11,8A	10Min.	--	230V <1A	520V <1A	Output a.c.relays operated, disconnected with grid. Error code"ID47(ParallelFault) No damaged. No hazards.
INSYN,TX1,IN SYN,RX1	Short	230V 15,5A	520V 11,8A	10Min.	--	230V <1A	520V <1A	Output a.c.relays operated, disconnected with grid. Error code"ID47(ParallelFault) No damaged. No hazards.
C384	Short	230V 15,5A	520V 11,8A	10Min.	--	230V <1A	520V <1A	Output a.c.relays operated, disconnected with grid. error code "ID81(SwBatOCP) . No damaged. No hazards.
EC6	Short	230V 15,5A	520V 11,8A	10Min.	--	230V <1A	520V <1A	The EUT shut down immediately. No damaged, no hazards.
EC9	Short	230V 15,5A	520V 11,8A	10Min.	--	230V <1A	520V <1A	The EUT shut down immediately. No damaged, no hazards.
EC11	Short	230V 15,5A	520V 11,8A	10Min.	--	230V <1A	520V <1A	The EUT shut down immediately. No damaged, no hazards.
U58	Short	230V 15,5A	520V 11,8A	10Min.	--	230V <1A	520V <1A	The EUT shut down immediately. No damaged, no hazards.
C463	Short	230V 15,5A	520V 11,8A	10Min.	--	230V <1A	520V <1A	Output a.c.relays operated, disconnected with grid. error code"GFCI fault" No damaged. No hazards

Component No.	Fault	Test condition		Test time	Fuse No,	Fault condition		Result
		AC	DC			AC	DC	
C105	Short	230V 15,5A	520V 11,8A	10Min.	--	230V <1A	520V <1A	Output a.c.relays operated, disconnected with grid. error code"CT current fault" No damaged. No hazards.
C130	Short	230V 15,5A	520V 11,8A	10Min.	--	230V <1A	520V <1A	Output a.c.relays operated, disconnected with grid. error code"OverTempDerating" No damaged. No hazards.
C107	Short	230V 15,5A	520V 11,8A	10Min.	--	230V <1A	520V <1A	Output a.c.relays operated, disconnected with grid. error code"HwLLCBusOCP" No damaged. No hazards.
C120	Short	230V 15,5A	520V 11,8A	10Min.	--	230V <1A	520V <1A	Output a.c.relays operated, disconnected with grid. error code"HwLLCBusOCP" No damaged. No hazards.

The errors in the control circuit simulate that the safety is even under one error ensured,

Addendum – Shutdown device

Each active phase can be switched, (L and N)

Yes

If no galvanic separation between AC and DC (PV):

Two relays in series on each active phase are necessary to fulfil the basic insulation or simple separation based on the PV working voltage,

Two relays in series on each active phase

Note:

The tests had been performed on the HYD 6000-EP is valid for the HYD 5500-EP, HYD 5000-EP, HYD 4600-EP , HYD 4000-EP, HYD 3680-EP and HYD 3000-EP, since it is identical in hardware and software construction except output power derated by software.

The test results refer to the test report "PVTR200917N016" issued by Bureau Veritas Shenzhen Co., Ltd. Dongguan Branch, dated on 2021.01.20.



Report No.: PVGR200917N016

Annex 1

Pictures of the unit

The full pictures refer to PHOTO DOCUMENT

Project No.: 200917N016

Date: 2021-01-12

Enclosure front view



Enclosure rear view



Enclosure bottom view



Enclosure side view

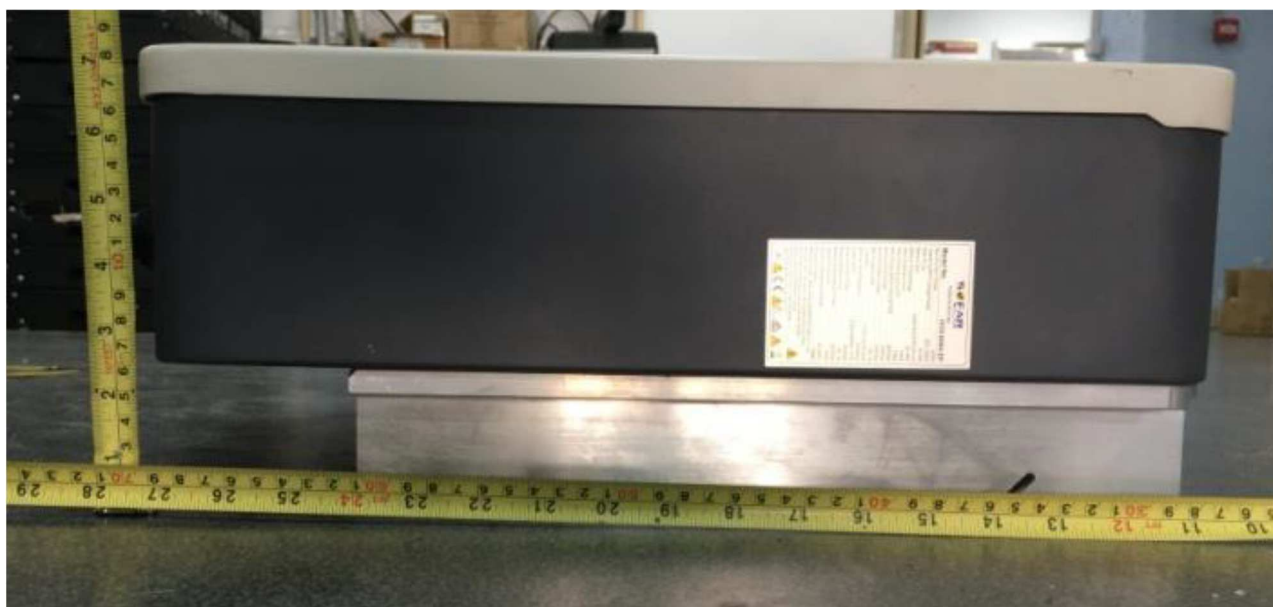



Report No.: PVGR200917N016

Annex No. 2

Test Equipment list

Test Local: Bureau Veritas Shenzhen Co., Ltd. Dongguan Branch
Dates of performer test: 2020-09-17 to 2021-01-15

Equipment	Internal No.	Manufacturer	Type	Serial No.	Last Calibration
Power Analyzer	A4080002DG	YOKOGAWA	WT3000	91M210852	Jun. 17, 2020
AC Source	A7040019DG	Chroma	61512	61512000439	Monitored by Power Analyzer
	A7040020DG	Chroma	61512	61512000438	
DC Simulation Power Supply	A7040015DG	Chroma	62150H-1000S	62150EF00488	
	A7040016DG	Chroma	62150H-1000S	62150EF00490	
RLC Load	A7150027DG	Qunling	ACLT-3803H	93VOO2869	
Eight Channel Digital Phosphor Oscilloscope	A4089017DG	YOKOGAWA	DL850	91N726247	Sep. 23, 2020
Four Channel Digital Phosphor Oscilloscope	A4089003DG	Tektronix	DPO4104B	C010624	Mar. 06, 2020
	//	KEYSIGHT	DSOX3014T	MY59243036	Jan. 05, 2021
Oscilloscope probel	A1490009DG	YOKOGAWA	701901	//	Sep. 03, 2020
	A1490010DG	YOKOGAWA	701901	//	Sep. 03, 2020
	A1490011DG	YOKOGAWA	701901	//	Sep. 03, 2020
Current transducer	A1060008DG	YOKOGAWA	CT200	1130700017	Sep. 03, 2020
	A1060009DG	YOKOGAWA	CT200	1130700019	Sep. 03, 2020
	A1060009DG	YOKOGAWA	CT200	1130700019	Sep. 03, 2020